



Commercial Stainless • Faucets • Equipment

# Price Book & Product Guide

Version May 2026

Underbar  
Work Tables  
Cabinets  
Sinks & Faucets  
Warmers & Proofers  
Shelving



# ATSMFG

**Front-of-House to Back-of-House. Exceptional Value, Reliable Quality**

Restaurant Furniture, Equipment, Stainless Steel, Tabletop, and Supplies – Competitively Priced Solutions

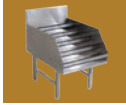
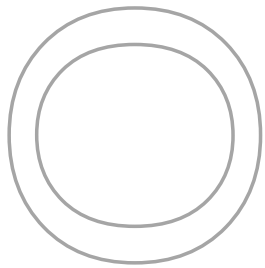
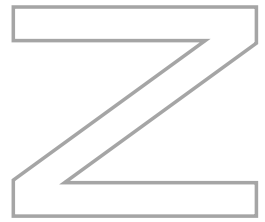
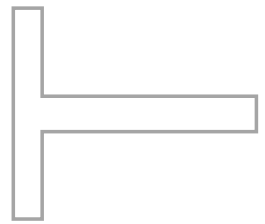
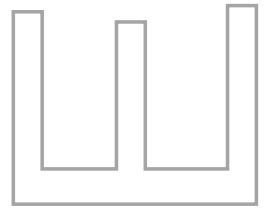
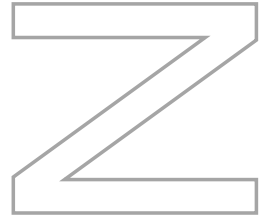
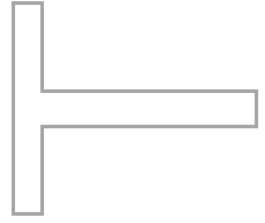

## MET UNDERBAR EQUIPMENT

Liquor Display .....	1
Glass Rack Station .....	1
Ice Bin .....	2
Ice Bin With Cold Plate .....	2
Ice Bin Cover .....	3
Blender Station .....	3
Bar Sink .....	4
Dump Sink & Underbar Hand Sink .....	4



## MET WORK TABLES & STANDS

Work Table with Backsplash, Heavy-duty .....	5
Work Table, Heavy-duty .....	6
Work Table, 18 Ga. ....	6
Work Table, Economy .....	7
Prep Table with Sink .....	8
Equipment Stand .....	9
Chip Warmer Cart .....	9
Rice Cooker Stand .....	10
Rice Warmer Cart .....	10



## MET DISH & BEVERAGE CABINETS

Beverage Cabinet with Urn Trough .....	11
Dish Cabinet with Sliding Doors .....	11
Dish Cabinet .....	12



## MET SINKS & DISH TABLES

Wall-mounted Hand Sink with Splashguard .....	13
Wall-mounted Hand Sink .....	13
Wall-mounted Mop Sink .....	14
1-Compartment Prep Sink .....	15
2-Compartment Prep Sink .....	16
3-Compartment Wash Sink .....	17
Soiled Dish Table Extension .....	18
Clean Dish Table Extension .....	19



## MET WALL SHELVES & POT RACKS

Wall Shelf .....	20
Wall Shelf with Pot Rack .....	20
Slanted Rack Wall Shelf .....	20
Tubular Drainage Shelf .....	21
Microwave Oven Shelf .....	21

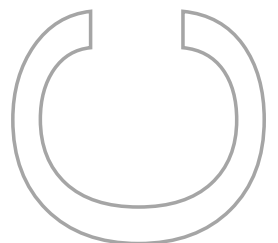
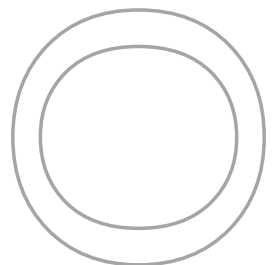
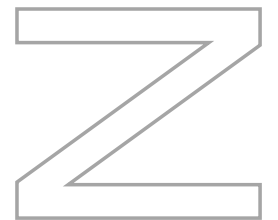
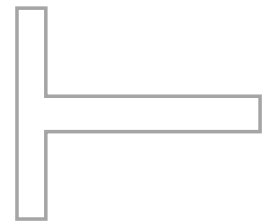
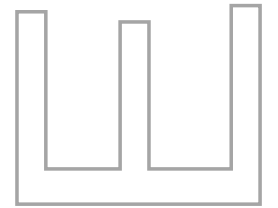
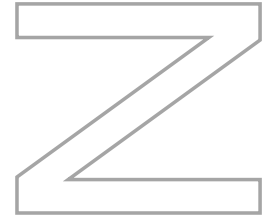
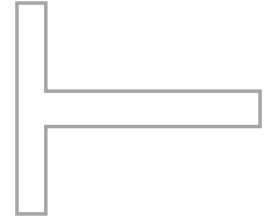

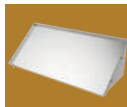

## MET WALL SHELVES & POT RACKS...

Ceiling Mounted Pot Rack .....	22
Wall-mounted Pot Rack .....	22



## FLO COMMERCIAL KITCHEN FAUCETS

Pre-rinse Faucet Sets, Heavy-duty .....	23
Wall-mounted Faucet, Heavy-duty .....	24
Wall-mounted Faucet, Commercial-duty .....	24
4" Mounted Faucets .....	25
4" Mounted Goose-neck Faucets .....	26
Wok Faucets .....	27
Mop Sink Faucet with Support Bracket .....	28



## LIT WARMERS, PROOFERS & WOK RANGE

Strip Warmer .....	29
Cook & Hold Warmer, Countertop .....	29
Chip Warmer .....	30
Wok Range .....	30
Warmer Drawers .....	31
Heated Holding & Proofing Cabinets .....	32

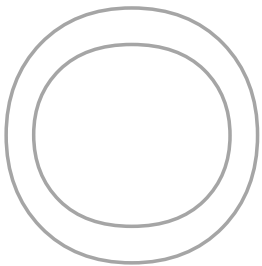
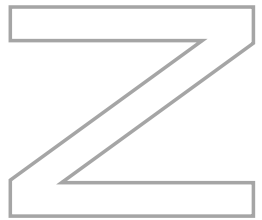
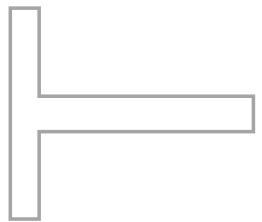
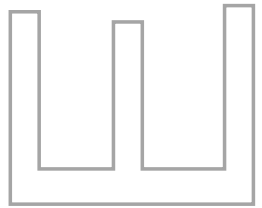
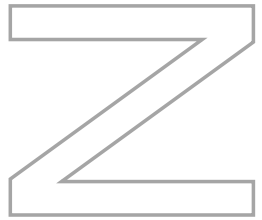
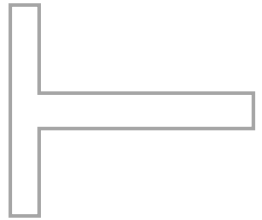



## SUPPLIES & MISCELLANEOUS

MET Stainless Steel Trash Receptacle .....	35
MET Epoxy-coated Wire Shelving .....	36
MET Keg Rack .....	37
MET Utility Carts .....	37
MET Bun Pan Rack .....	38
LIT Swinging Traffic Door .....	38
LIT Counter-mounted Can Opener .....	39
LIT Heat-seal Film Wrapping Dispenser .....	39

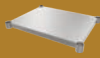

## MET PARTS & ACCESSORIES

Stainless Steel Work Table Undershelf .....	40
Stainless Steel Double Overshelf .....	40
Caster Sets for Work Tables & Equipment Stands .....	41
Epoxy-coated Shelving Parts .....	42
Stainless Steel Baskets / Splash Guards .....	43
Work Table Drawer .....	44
Fryer Accessories .....	44
Hood Filters .....	45

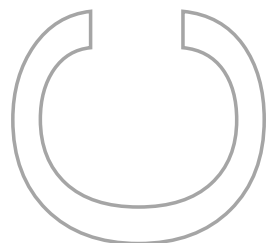
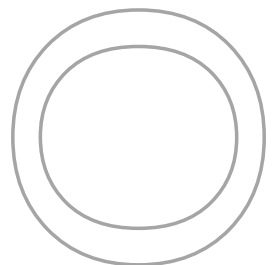
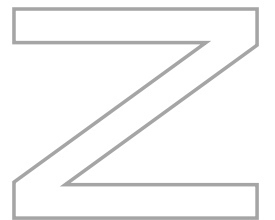
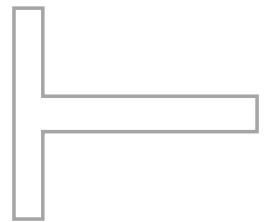
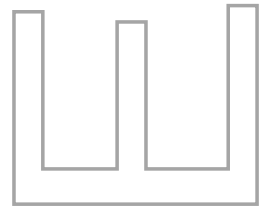
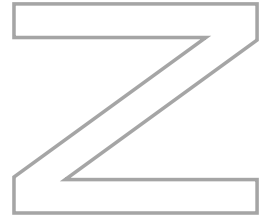
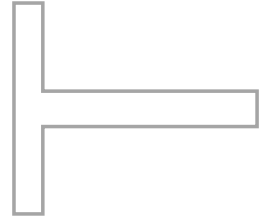

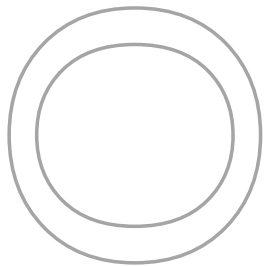
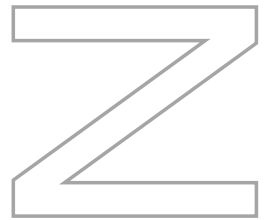
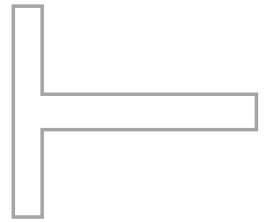
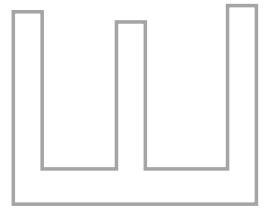
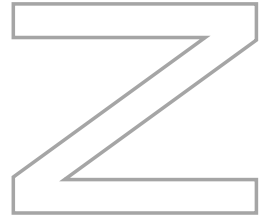
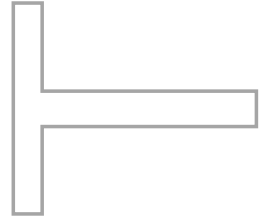

## FLO PARTS & ACCESSORIES

Operation Valve – Knee Action .....	46
Operation Valve – Foot Action .....	46
Waste Water Valve – Lever Handle Style .....	47
Waste Water Valve – Twist Handle Style .....	47
Wall-mounted Faucet Parts .....	48
4" Mount Faucet Parts .....	48
Wok Faucet Parts .....	48
Pre-rinse Wall-mounted Base .....	49
Operation Valve Parts .....	49
Handle Waste Valve with Strainer Parts .....	49



## LIT PARTS & ACCESSORIES

Strip Heater Stand .....	50
Can Opener Parts .....	50

 MET

 FLO

 LIT

T  
Z  
E  
M  
P  
D  
Q  
E



## Liquor Display

- 304 S/S 16 Ga. side panels
- 304 S/S 18 Ga. bottom & back panels
- 4" or 6" backsplash
- S/S legs with side cross bracing
- NSF listed



MET-LQD-18  
MET-LQD-24



MET-LQD-12  
MET-LQD-30  
MET-LQD-36



MET-LQDR-3625  
6" Backsplash



MODEL NO.	DIMENSION	LBS	LIST PRICE
MET-LQD-12	D21-1/8" W12" H33"	30	\$ 972
MET-LQD-18	D24 -1/2" W18" H33"	35	\$ 1,019
MET-LQD-24	D24 -1/2" W24" H33"	41	\$ 1,114
MET-LQD-30	D21-1/8" W30" H33"	48	\$ 1,186
MET-LQD-36	D21-1/8" W36" H33"	52	\$ 1,281
MET-LQDR-3625*	D25" W36" H30"	53	\$ 1,186

## Glass Rack Station

- 304 S/S 20 Ga. sink top drain board
- 430 S/S body & side panels
- 4" backsplash
- Heavy duty adjustable S/S bullet feet
- NSF listed



MET-UBGR-243

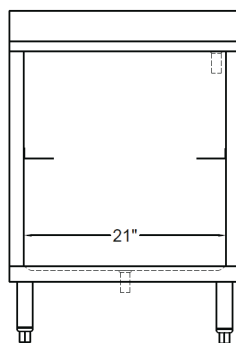

Front View

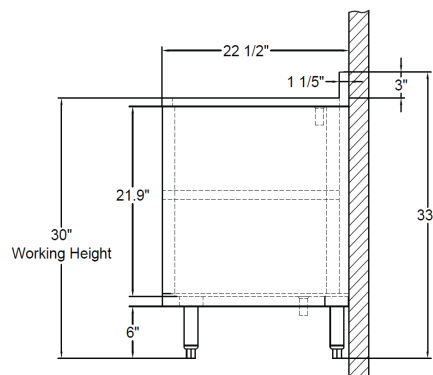

Left Side View

MODEL NO.	DIMENSION	LBS	LIST PRICE
MET-UBGR-242	D21-1/8" W12" H33"	50.9	\$ 782
MET-UBGR-243	D21-1/8" W18" H33"	50.6	\$ 782

Effective May 2026

## Ice Bin

- 304 S/S 18 Ga. sink top & bowl
- 430 S/S front & side panels
- 4" backsplash
- Poly foam insulation
- S/S legs with side cross bracing
- NSF listed



MET-UBIB-24

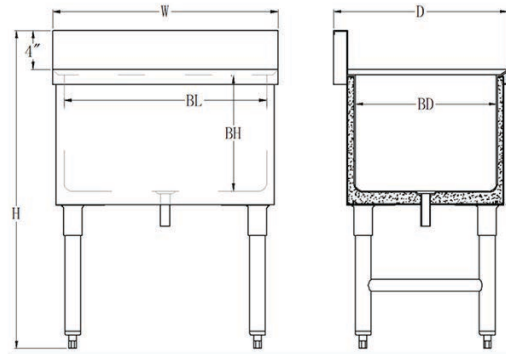

MODEL NO.	DIMENSION	BD X BW X BH	LBS	LIST PRICE
MET-UBIB-1824	D18-1/2" W24" H33"	15" x 21" x 12"	48	\$ 877
MET-UBIB-1830	D18-1/2" W30" H33"	15" x 27" x 12"	55	\$ 948
MET-UBIB-1836	D18-1/2" W36" H33"	15" x 33" x 12"	65	\$ 1091
MET-UBIB-1848	D18-1/2" W48" H33"	15" x 45" x 12"	79	\$ 1328

- See Ice Bin Cover Available on Page 3

## Ice Bin with Cold Plate

- 304 S/S construction
- S/S legs and sockets
- H shape welded leg bracing
- Approximately 96-98 lbs ice capacity
- 3" height back splash
- (2) Removable plastic bottle racks
- NSF listed



MET-UBIB-247-CP

MODEL NO.	DIMENSION	BOWL DEPTH	COLD PLATE	LIST PRICE
MET-UBIB-247-CP	D18-1/2" W24" H30"	12"	7-circuit cold plate	\$ 2611
MET-UBIB-307-CP	D18-1/2" W30" H30"	12"		\$ 2848
MET-UBIB-367-CP	D18-1/2" W36" H30"	12"		\$ 3086
MET-UBIB-2410-CP	D18-1/2" W24" H30"	12"	10-circuit cold plate	\$ 3086
MET-UBIB-3010-CP	D18-1/2" W30" H30"	12"		\$ 3323
MET-UBIB-3610-CP	D18-1/2" W36" H30"	12"		\$ 3561

- See Ice Bin Cover Available on Page 3

Effective May 2026

## Ice Bin Cover



MET-IBSC-30



- Ice bin sliding cover
- 18/304 stainless steel construction
- NSF listed

FOR BINS WITHOUT COLD PLATES			
MODEL NO.	WIDTH	FOR MODEL	NET
MET-IBSC-24	24"	UBIB-1824 (2024)	\$ 236
MET-IBSC-30	30"	UBIB-1830	\$ 283
MET-IBSC-36	36"	UBIB-1836	\$ 331
MET-IBSC-48	48"	UBIB-1848	\$ 402

FOR BINS WITH COLD PLATES			
MODEL NO.	WIDTH	FOR MODEL	NET
MET-IBSC-24-CP	24"	UBIB-1824 UBIB-247-CP UBIB-2410-CP	\$ 236
MET-IBSC-30-CP	30"	UBIB-307-CP UBIB-3010-CP	\$ 283
MET-IBSC-36-CP	36"	UBIB-367-CP UBIB-3610-CP	\$ 331

## Blender Station

- 304 S/S 20 Ga. sink top drain board
- 304 S/S body & side panels
- 4" backsplash
- Heavy duty adjustable S/S bullet feet
- 4" Wall-mounted faucet & 1-1/2" drain included
- NSF listed



MET-UBBS-1824

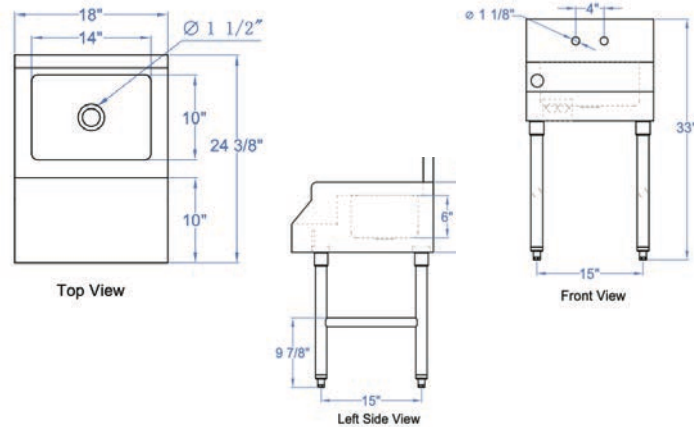

MODEL NO.	DIMENSION	BD X BW X BH	LBS	LIST PRICE
MET-UBBS-1824	D24-3/8" W18" H 33"	10" x 12" x 6"	28	\$ 853

- See Faucet Upgrade FLO 4 Series (Wall-mounted) Page 25 & 26

## Bar Sink

- 304 S/S 20 Ga. sink top & bowl
- 430 S/S front & side panels
- 4" backsplash
- 12" left & right drain boards (with drain board models)
- S/S legs with side cross bracing
- 4" Wall-mounted faucet & 1-1/2" drains included
- NSF listed



MET-UBS-246

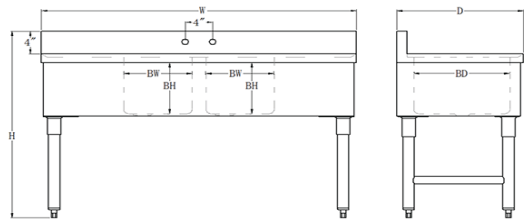

MODEL NO.	DIMENSION	# OF SINK BOWL	# OF DRAIN BOARD	BD x BW x BH	LBS	LIST PRICE
MET-UBS-227	D18-1/2" W24" H33"	2	0	14" x 10" x 10"	43	\$ 948
MET-UBS-246	D18-1/2" W46" H33"	2	2	14" x 10" x 10"	51	\$ 1186
MET-UBS-339	D18-1/2" W39" H33"	3	0	14" x 10" x 10"	55	\$ 1304
MET-UBS-358	D18-1/2" W58" H33"	3	2	14" x 10" x 10"	62	\$ 1423
MET-UBS-470	D18-1/2" W70" H33"	4	2	14" x 10" x 10"	78	\$ 2278

- See Faucet Upgrade FLO 4 Series (Wall-mounted) Available on Page 26 & 27

## Dump Sink & Underbar Hand Sink

- 304 S/S 20 Ga. sink top & bowl
- 430 S/S front & side panels
- 4" backsplash
- S/S legs with side cross bracing
- One compartment, no drain boards
- 4" Wall-mounted faucet & 1-1/2" drain included
- NSF listed

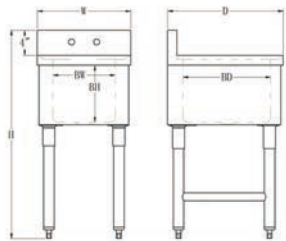

MET-UBS-118

- 304 S/S 20 Ga. construction
- 3" backsplash
- Soap and towel dispenser included
- 4" Wall-mounted faucet & 1-1/2" drainer included
- NSF listed



MET-UBHS-12ST



MODEL NO.	DIMENSION	LBS	LIST PRICE
MET-UBS-118	D18-1/2" W15" H33"	39	\$ 711

MODEL NO.	DIMENSION	LBS	LIST PRICE
MET-UBHS-12ST	D22-1/2" W12" H33"	31	\$ 594
MET-UBHS-18ST	D22-1/2" W18" H 33"	36	\$ 654

- See Faucet Upgrade FLO 4 Series Available on Page 26

## Work Table with Backsplash, Heavy-duty

- 304 S/S 16 Ga. table top
- 430 S/S 18 Ga. undershelf
- 5" backspalsh
- Table top reinforced with hat channel
- S/S legs with adjustable S/S bullet feet
- Work table 72" & over in length uses 6 legs
- Shipped knocked-down in a box
- NSF listed

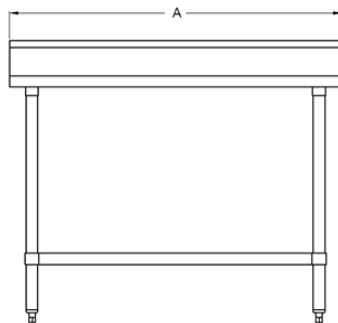

Front View

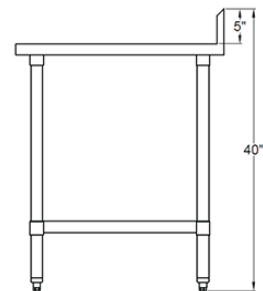

Side View



MET-WTHB-3096



MET-WTHB-3048

MODEL NO.	DIMENSION	A	LBS	LIST PRICE
MET-WTHB-3024	D30" W24" H43"	24"	47	\$ 544
MET-WTHB-3036	D30" W36" H43"	36"	58	\$ 663
MET-WTHB-3048	D30" W48" H43"	48"	73	\$ 782
MET-WTHB-3060	D30" W60" H43"	60"	89	\$ 901
MET-WTHB-3072	D30" W72" H43"	72"	109	\$ 1,091
MET-WTHB-3096	D30" W96" H43"	96"	145	\$ 1,423

- See Undershelf Available on Page 40

## Work Table, Heavy-duty

MODEL NO.	DIMENSION	A	LBS	LIST PRICE
MET-WTH-2430	D24" W30" H35"	18"	42	\$ 544
MET-WTH-2436	D24" W36" H35"	18"	48	\$ 592
MET-WTH-2448	D24" W48" H35"	18"	58	\$ 663
MET-WTH-2460	D24" W60" H35"	18"	69	\$ 782
MET-WTH-2472	D24" W72" H35"	18"	86	\$ 948
MET-WTH-3030	D30" W30" H35"	24"	50	\$ 568
MET-WTH-3036	D30" W36" H35"	24"	57	\$ 663
MET-WTH-3048	D30" W48" H35"	24"	70	\$ 711
MET-WTH-3060	D30" W60" H35"	24"	83	\$ 829
MET-WTH-3072	D30" W72" H35"	24"	105	\$ 1,019
MET-WTH-3096	D30" W96" H35"	24"	141	\$ 1,423

- 304 S/S 16 Ga. table top
- 430 S/S 18 Ga. undershelf
- Table top reinforced with hat channel
- S/S legs with adjustable S/S bullet feet
- Work table 72" & over in length uses 6 legs
- Shipped knocked-down in a box
- NSF listed



MET-WTH-2430



- See Undershelf and Double Overshelf Available on Page 40
- See Work Table Caster Available on Page 41

## Work Table, 18 Ga.

- 430 S/S 18 Ga. table top & undershelf
- Table top reinforced with hat channel
- S/S legs with adjustable S/S bullet feet
- Work table 72" & over in length uses 6 legs
- Shipped knocked-down in a box
- NSF listed



MET-WT-2436

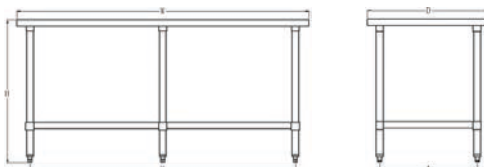

- See Undershelf and Overshelf on Page 49
- See Work Table Casters Available on Page 41

MODEL NO.	DIMENSION	A	LBS	LIST PRICE
MET-WT-2412	D24" W12" H35"	18"	22	\$ 307
MET-WT-2415	D24" W15" H35"	18"	25	\$ 331
MET-WT-2418	D24" W18" H35"	18"	29	\$ 354
MET-WT-2424	D24" W24" H35"	18"	34	\$ 378
MET-WT-2430	D24" W30" H35"	18"	39	\$ 402
MET-WT-2436	D24" W36" H35"	18"	45	\$ 449
MET-WT-2448	D24" W48" H35"	18"	53	\$ 521
MET-WT-2460	D24" W60" H35"	18"	63	\$ 568
MET-WT-2472	D24" W72" H35"	18"	79	\$ 639
MET-WT-3012	D30" W12" H35"	24"	24	\$ 331
MET-WT-3015	D30" W15" H35"	24"	28	\$ 345
MET-WT-3018	D30" W18" H35"	24"	34	\$ 354
MET-WT-3030	D30" W30" H35"	24"	46	\$ 426
MET-WT-3036	D30" W36" H35"	24"	54	\$ 449
MET-WT-3048	D30" W48" H35"	24"	65	\$ 521
MET-WT-3060	D30" W60" H35"	24"	79	\$ 616
MET-WT-3072	D30" W72" H35"	24"	98	\$ 734

Effective May 2026

## Work Table, Economy

- 430 S/S 18 Ga. table top
- 18 Ga. galvanized undershelf
- Table top reinforced with hat channel
- Galvanized legs with adjustable plastic bullet feet
- All work table uses 4 legs
- Shipped knocked-down in a box
- NSF listed

MET-WTE-2448\*

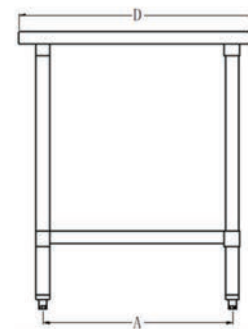

MODEL NO.	DIMENSION	A	B	LBS	LIST PRICE
MET-WTE-2430*	D24" W30" H35"	18"	23-3/8"	39	\$ 283
MET-WTE-2436*	D24" W36" H35"	18"	29-3/8"	45	\$ 307
MET-WTE-2448*	D24" W48" H35"	18"	41-3/8"	53	\$ 331
MET-WTE-2460*	D24" W60" H35"	18"	53-3/8"	63	\$ 378
MET-WTE-2472*	D24" W72" H35"	18"	65-3/8"	79	\$ 426
MET-WTE-3015*	D30" W15" H35"	24"	10-1/8"	28	\$ 236
MET-WTE-3018*	D30" W18" H35"	24"	13-1/8"	34	\$ 250
MET-WTE-3030*	D30" W30" H35"	24"	23-3/8"	46	\$ 307
MET-WTE-3036*	D30" W36" H35"	24"	29-3/8"	54	\$ 331
MET-WTE-3048*	D30" W48" H35"	24"	41-3/8"	65	\$ 378
MET-WTE-3060*	D30" W60" H35"	24"	53-3/8"	79	\$ 449
MET-WTE-3072*	D30" W72" H35"	24"	65-3/8"	98	\$ 497

- See S/S Undershelf and Double Overshelf Available on Page 40
- See Work Table Casters Available on Page 41

## Prep Table with Sink



MET-WTPS-3048R



MET-WTPS-3072R

- 304 S/S 18 Ga. table top and sink bowl
- 6" backsplash
- 4"OC deck mount faucet hole
- 3-1/2" strainer hole, strainer included
- Stainless steel under shelf
- Adjustable S/S bullet feet
- NSF listed

MODEL NO.	DIMENSION	SINK BOWL	LBS	LIST PRICE
MET-WTPS-3048L	D30" W48" H35"	Left	81	\$ 1,423
MET-WTPS-3048R	D30" W48" H35"	Right	81	\$ 1,423
MET-WTPS-3060L	D30" W60" H35"	Left	94	\$ 1,661
MET-WTPS-3060R	D30" W60" H35"	Right	94	\$ 1,661
MET-WTPS-3072L	D30" W72" H35"	Left	106	\$ 1,898
MET-WTPS-3072R	D30" W72" H35"	Right	106	\$ 1,898

- Faucet not included
- See FLO 4 Series (Deck Mount) Available on Page 27

## Equipment Stand

- 304 S/S 16 Ga. table top
- Table top is built 3-sided 1.5" turn up
- Table top is reinforced with hat channel
- S/S legs with adjustable S/S bullet feet
- Equipment stand with 60" & over in length uses 6 legs
- Shipped knocked-down in a box
- NSF listed



MET-ES-3036

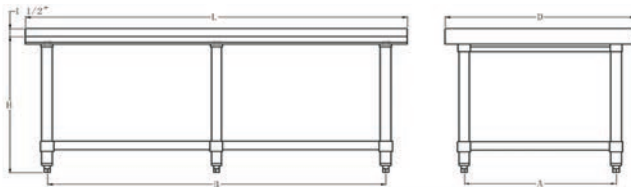

MODEL NO.	DIMENSION	A	B	LBS	LIST PRICE
MET-ES-3012	D30" W12" H26"	24"	7"	27	\$ 331
MET-ES-3018	D30" W18" H26"	24"	13-1/3"	35	\$ 354
MET-ES-3024	D30" W24" H26"	24"	17-1/2"	40	\$ 402
MET-ES-3030	D30" W30" H26"	24"	22-1/2"	44	\$ 426
MET-ES-3036	D30" W36" H26"	24"	29-1/2"	52	\$ 473
MET-ES-3048	D30" W48" H26"	24"	41-1/2"	68	\$ 567
MET-ES-3060	D30" W60" H26"	24"	53-1/2"	88	\$ 782
MET-ES-3072	D30" W72" H26"	24"	65-1/2"	101	\$ 877

- See Equipment Stand Caster (CS4153 & CS6155) Available on Page 41

## Chip Warmer Cart



MET-ES-27VCW

MODEL NO.	DIMENSION	LBS	LIST PRICE
MET-ES-27VCW	D29 1/4" W31 1/4" H44"	43	\$ 948

- For LIT brands AECW Chit Warmer, See Page 30



Effective May 2026

## Rice Cooker Stand



MET-ES-20

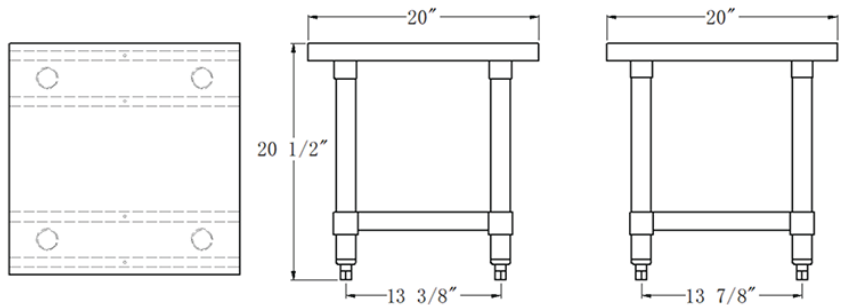

- 430 S/S 18 Ga. table top & undershelf
- Table top reinforced with hat channel
- S/S leg with adjustable S/S bullet feet
- Shipped knocked-down in a box
- NSF listed

MODEL NO.	DIMENSION	LBS	LIST PRICE
MET-ES-20	D20" W20" H20-1/2"	24	\$ 331

## Rice Warmer Cart



MET-ES-15

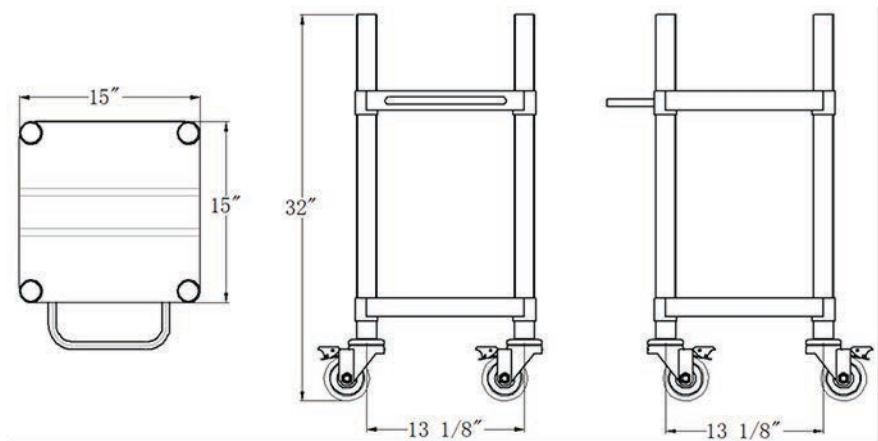

- 430 S/S 18 Ga. table top & undershelf
- S/S leg with 4" caster with break
- Shipped knocked-down in a box
- NSF listed

MODEL NO.	DIMENSION	LBS	LIST PRICE
MET-ES-15	D15" W15" H32"	29	\$ 402

## Beverage Cabinet with Urn Trough

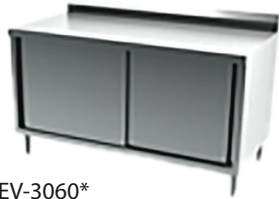

MET-BEV-3060\*



- Built-in urn trough with drain
- 16 gauge stainless steel top
- 18 gauge stainless steel body
- 5" riser backsplash with standard electric outlet
- Stainless steel legs
- NSF listed

MODEL NO.	DIMENSION	LBS	# OF ADJUSTABLE SHELF	LIST PRICE
MET-BEV-3036*	D30" W36"	171	1	\$ 2,136
MET-BEV-3048*	D30" W48"	211	1	\$ 2,373
MET-BEV-3060*	D30" W60"	251	1	\$ 2,611
MET-BEV-3072*	D30" W72"	291	1	\$ 2,848

## Dish Cabinet with Sliding Doors



MET-CTD-3060

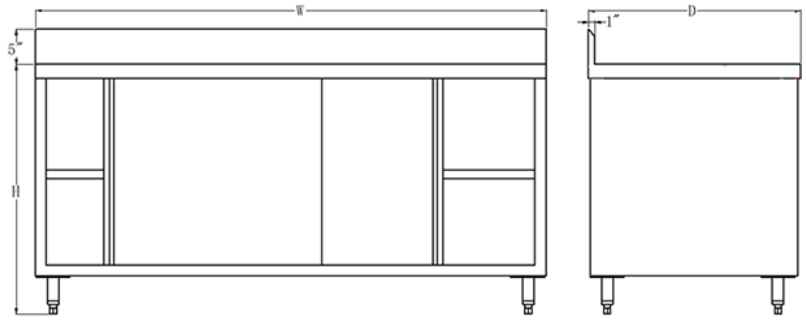

- 304 S/S 16 Ga. Top
- 430 S/S 18 Ga. body panels & shelf
- 5" backsplash
- Intermediate shelf & sliding doors
- Heavy duty adjustable S/S bullet feet
- NSF listed

MODEL NO.	DIMENSION	WEIGHT	LIST PRICE
MET-CTD-3036	D30" W36" H35"	165	\$ 1898
MET-CTD-3048	D30" W48" H35"	204	\$ 2,136
MET-CTD-3060	D30" W60" H35"	241	\$ 2,373
MET-CTD-3072	D30" W72" H35"	279	\$ 2,611

Effective May 2026

1750 Stone Ridge Drive, Stone Mountain, Georgia | CSR@ATSMFG.com | 770-270-1688

## Dish Cabinet

- 430 S/S 18 Ga. top
- 430 S/S 22 Ga. body panels & shelf
- Intermediate shelf
- Heavy duty adjustable S/S bullet feet
- Shipped knocked-down in a box
- NSF listed

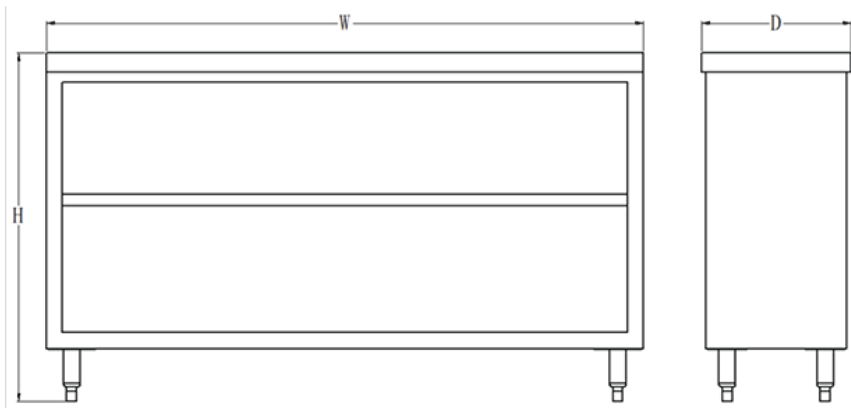

MET-CDN-1560

MODEL NO.	DIMENSION	LBS	LIST PRICE
MET-CDN-1536	D15" W36" H35"	57	\$ 948
MET-CDN-1548	D15" W48" H35"	71	\$ 1,114
MET-CDN-1560	D15" W60" H35"	83	\$ 1,281
MET-CDN-1572	D15" W72" H35"	92	\$ 1,423

## Wall-mounted Hand Sink

- 6" height backsplash with 2" return
- 304 S/S sink top and bowl
- Z-clip mounting bracket included
- 4" Wall-mounted faucet and 1-1/2" drainer included
- NSF listed



MET-HS-1517BS

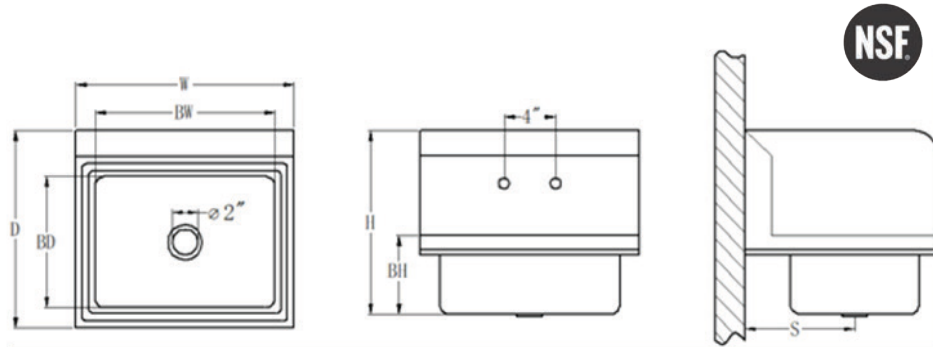

MODEL NO.	DIMENSION	BD X BW X BH	S	LBS	LIST PRICE
MET-HS-1512BS	D15-3/4" W12" H14"	9" x 9" x 3-3/4"	8-1/2"	10	\$ 331
MET-HS-1517BS	D15" W17" H14"	10" x 14" x 6"	8-1/2"	16	\$ 354



MET-HS-1517S

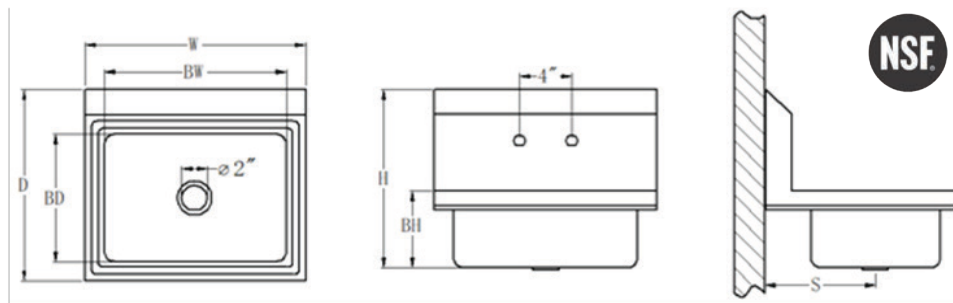

MODEL NO.	DIMENSION	BD X BW X BH	S	LBS	LIST PRICE
MET-HS-1512S	D15-3/4" W12" H14"	9" x 9" x 3-3/4"	8-1/2"	7	\$ 283
MET-HS-1517S	D15-3/4" W17" H14"	10" x 14" x 6"	8-1/2"	13	\$ 307

- See Faucet Upgrade FLO 4 Series (Wall-mounted) Available on Page 25 & 26

## Wall-mounted Mop Sink

- 304 S/S 18 Ga. sink top & bowl
- 304 S/S 18 Ga. body panels
- 3-1/2" Drain included
- NSF listed



MET-SEM-201610

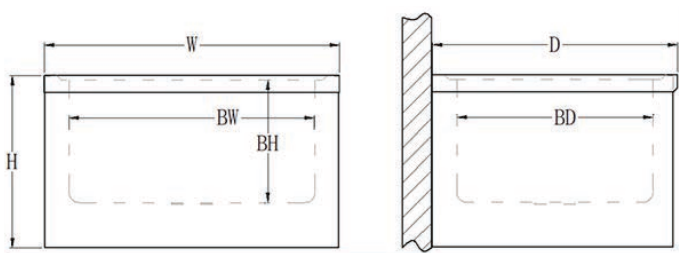

MODEL NO.	DIMENSION	BD X BW X BH	LBS	LIST PRICE
MET-SEM-201610	D20" W24" H14"	16" x 20" x 10"	30	\$ 711
MET-SEM-202010	D24" W24" H14"	20" x 20" x 10"	35	\$ 782

- See Service Faucet FLO 840 (Wall-mounted) Available on Page 28

## 1-Compartment Prep Sink

- 11-1/2" height backsplash
- 304 S/S 16 Ga. or 18 Ga. sink top and bowl
- 8" OC splash mount faucet hole
- 3-1/2" strainer hole, drain basket included
- Stainless steel legs with side cross bracing
- NSF listed

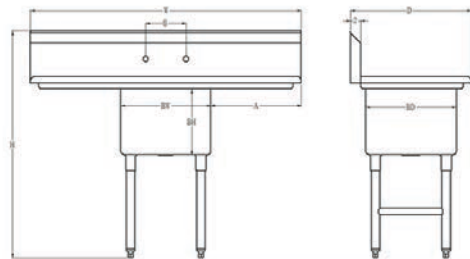

N  
No Drain Board

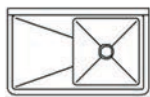

L  
Left Drain Board

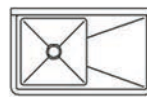

R  
Right Drain Board

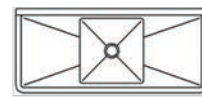

D  
Left & Right Drain Board



MET-SE-15151N

1-COMPARTMENT PREP SINK WITHOUT DRAIN BOARD						
MODEL NO.	DIMENSION	BD X BW X BH	GAUGE	LBS	LIST PRICE	
MET-SE-15151N	D18-5/8" W18-1/4" H43-7/8"	15" x 15" x 13"	18	27	\$ 663	
MET-SE-18181N	D21-5/8" W21-1/4" H43-7/8"	18" x 18" x 13"	18	31	\$ 711	
MET-SEH-20201N	D26" W23-1/4" H45"	20" x 20" x 14"	16	41	\$ 948	
MET-SEH-24241N	D27-5/8" W27-1/4" H43-7/8"	24" x 24" x 13"	16	48	\$ 1,186	



MET-SE-15151L

1-COMPARTMENT PREP SINK WITH LEFT DRAIN BOARD						
MODEL NO.	DIMENSION	BD X BW X BH	A	GAUGE	LBS	LIST PRICE
MET-SE-15151L	D21" W33" H45"	15" x 15" x 12"	15"	18	33	\$ 711
MET-SE-18181L	D24" W39" H45"	18" x 18" x 12"	18"	18	42	\$ 853
MET-SEH-20201L	D26" W43" H45"	20" x 20" x 14"	20"	16	56	\$ 1,186
MET-SEH-24241L	D30" W51" H45"	24" x 24" x 14"	24"	16	71	\$ 1,328



MET-SE-15151R

1-COMPARTMENT PREP SINK WITH RIGHT DRAIN BOARD						
MODEL NO.	DIMENSION	BD X BW X BH	A	GAUGE	LBS	LIST PRICE
MET-SE-15151R	D21" W33" H45"	15" x 15" x 12"	15"	18	33	\$ 711
MET-SE-18181R	D24" W39" H45"	18" x 18" x 12"	18"	18	42	\$ 853
MET-SEH-20201R	D26" W43" H45"	20" x 20" x 14"	20"	16	56	\$ 1,186
MET-SEH-24241R	D30" W51" H45"	24" x 24" x 14"	24"	16	71	\$ 1,328



MET-SE-15151D

1-COMPARTMENT PREP SINK WITH LEFT & RIGHT DRAIN BOARD						
MODEL NO.	DIMENSION	BD X BW X BH	A	GAUGE	LBS	LIST PRICE
MET-SE-18181D	D24" W54" H45"	18" x 18" x 12"	18"	18	52	\$ 948
MET-SEH-24241D	D30" W72" H45"	24" x 24" x 14"	24"	16	86	\$ 1,566

• See FLO Faucet 7 & 8 Series Available on Page 24

## 2-Compartment Prep Sink

- 11-1/2" height backsplash
- 304 S/S 16 Ga. or 18 Ga. sink top and bowl
- 8" OC splash mount faucet hole
- 3-1/2" strainer hole, drain basket included
- Stainless steel legs with side cross bracing
- NSF listed

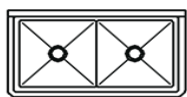
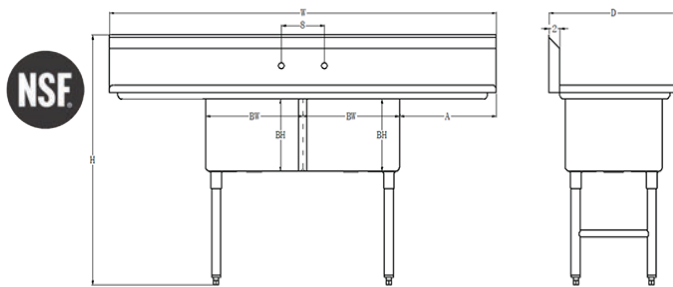

N  
No Drain Board

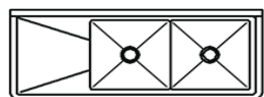

L  
Left Drain Board

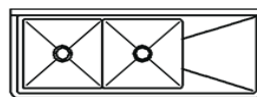

R  
Right Drain Board

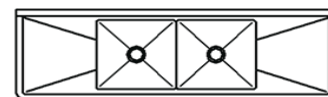

D  
Left & Right Drain Board



MET-SE-18182N

2-COMPARTMENT PREP SINK WITHOUT DRAIN BOARD					
MODEL NO.	DIMENSION	BD X BW X BH	GAUGE	LBS	LIST PRICE
MET-SE-18182N	D24" W42" H45"	18" x 18" x 12"	18	55	\$ 1,138
MET-SEH-24242N	D30" W54" H45"	24" x 24" x 12"	16	96	\$ 1,661



MET-SE-18182L

2-COMPARTMENT PREP SINK WITH LEFT DRAIN BOARD						
MODEL NO.	DIMENSION	BD X BW X BH	A	GAUGE	LBS	LIST PRICE
MET-SE-18182L	D24" W57" H45"	18" x 18" x 12"	18"	18	62	\$ 1,328
MET-SEH-24242L	D30" W75" H45"	24" x 24" x 14"	24"	16	110	\$ 1,803



MET-SE-18182R

2-COMPARTMENT PREP SINK WITH RIGHT DRAIN BOARD						
MODEL NO.	DIMENSION	BD X BW X BH	A	GAUGE	LBS	LIST PRICE
MET-SE-18182R	D24" W57" H45"	18" x 18" x 12"	18"	18	62	\$ 1,328
MET-SEH-24242R	D30" W75" H45"	24" x 24" x 14"	24"	16	110	\$ 1,803



MET-SE-18182D

2-COMPARTMENT PREP SINK WITH LEFT & RIGHT DRAIN BOARD						
MODEL NO.	DIMENSION	BD X BW X BH	A	GAUGE	LBS	LIST PRICE
MET-SE-18182D	D24" W72" H45"	18" x 18" x 12"	18"	18	69	\$ 1,423
MET-SEH-24242D	D30" W96" H45"	24" x 24" x 14"	24"	16	125	\$ 2,041

- See FLO Faucet 7 & 8 Series Available on Page 24

## 3-Compartment Wash Sink

- 11-1/2" height backsplash
- 304 S/S 16 Ga. or 18 Ga. sink top and bowl
- 8" OC splash mount faucet hole
- 3-1/2" strainer hole, drain basket included
- Stainless steel legs with side cross bracing
- NSF listed

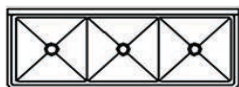
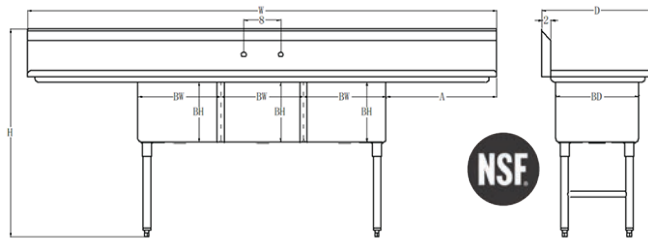

N  
No Drain Board

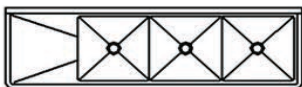

L  
Left Drain Board

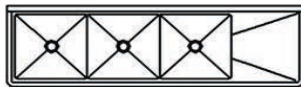

R  
Right Drain Board

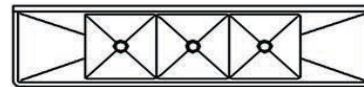

D  
Left & Right Drain Board



MET-SE-18183N

### 3-COMPARTMENT WASH SINK WITHOUT DRAIN BOARD

MODEL NO.	DIMENSION	BD X BW X BH	GAUGE	LBS	LIST PRICE
MET-SE-18183N	D24" W60" H45"	18" x 18" x 12"	18	74	\$ 1,613
MET-SEH-24243N	D30" W78" H45"	24" x 24" x 12"	18	134	\$ 2,611



MET-SE-18183L

### 3-COMPARTMENT WASH SINK WITH LEFT DRAIN BOARD

MODEL NO.	DIMENSION	BD X BW X BH	A	GAUGE	LBS	LIST PRICE
MET-SE-18183L	D24" W75" H45"	18" x 18" x 12"	18"	18	82	\$ 1,732
MET-SEH-24243L	D30" W99" H45"	24" x 24" x 14"	24"	16	149	\$ 2,848



MET-SE-18183R

### 3-COMPARTMENT WASH SINK WITH RIGHT DRAIN BOARD

MODEL NO.	DIMENSION	BD x BW x BH	A	Gauge	LBS	LIST PRICE
MET-SE-18183R	D24" W75" H45"	18" x 18" x 12"	18"	18	82	\$ 1,732
MET-SEH-24243R	D30" W99" H45"	24" x 24" x 14"	24"	16	149	\$ 2,848



MET-SE-18183D

### 3-COMPARTMENT WASH SINK WITH LEFT & RIGHT DRAIN BOARD

MODEL NO.	DIMENSION	BD X BW X BH	A	GAUGE	LBS	LIST PRICE
MET-SE-15153D	D21" W75" H45"	15" x 15" x 12"	15"	18	74	\$ 1,542
MET-SE-18183D	D24" W90" H45"	18" x 18" x 12"	18"	18	90	\$ 1,898
MET-SE-18183D24*	D24" W102" H45"	18" x 18" x 12"	24"	18	96	\$ 1,898
MET-SE-16203D18*	D26" W84" H45"	20" x 16" x 12"	18"	18	90	\$ 1,779
MET-SE-16203D24*	D26" W96" H45"	20" x 16" x 12"	24"	18	96	\$ 2,136
MET-SEH-20203D	D26" W100" H45"	20" x 20" x 14"	18"	16	132	\$ 2,611
MET-SEH-24243D	D30" W120" H45"	24" x 24" x 14"	24"	16	164	\$ 3,086

- See FLO Faucet 9 Series Pre-rinse Available on Page 23
- See FLO Faucet 7 & 8 Series Available on Page 24

## Soiled Dish Table Extension

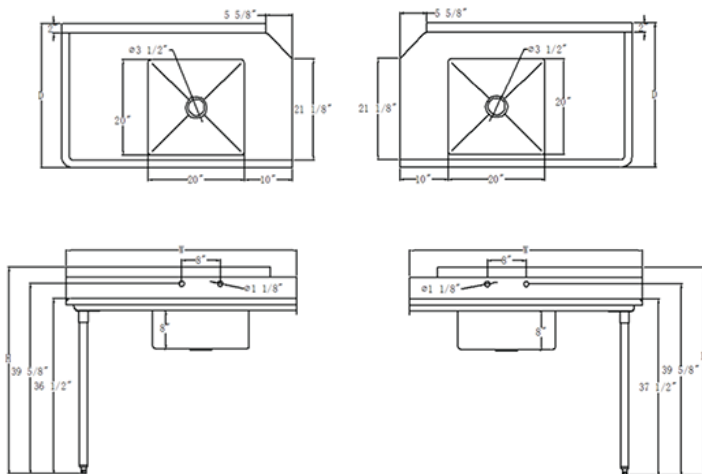

- 9" height backsplash
- 304 S/S 16 Ga. table top and sink bowl
- 20"L x 20"W x 8"H bowl size
- 8"OC splash mount faucet hole
- 3-1/2" strainer hole, strainer included
- Stainless steel legs with side cross bracing
- NSF listed



MET-SDT-36L



MET-SDT-36R

MODEL NO.	DIMENSION	LBS	LIST PRICE
MET-SDT-30L	D30" W30" H43"	48	\$ 948
MET-SDT-30R	D30" W30" H43"	48	\$ 948
MET-SDT-36L	D30" W36" H43"	53	\$ 1,019
MET-SDT-36R	D30" W36" H43"	53	\$ 1,019
MET-SDT-48L	D30" W48" H43"	57	\$ 1,186
MET-SDT-48R	D30" W48" H43"	57	\$ 1,186
MET-SDT-60L	D30" W60" H43"	69	\$ 1,304
MET-SDT-60R	D30" W60" H43"	69	\$ 1,304
MET-SDT-72L	D30" W72" H43"	79	\$ 1,423
MET-SDT-72R	D30" W72" H43"	79	\$ 1,423

• See FLO Faucet 7 & 8 Series Available on Page 24

Effective May 2026

1750 Stone Ridge Drive, Stone Mountain, Georgia | CSR@ATSMFG.com | 770-270-1688

## Clean Dish Table Extension

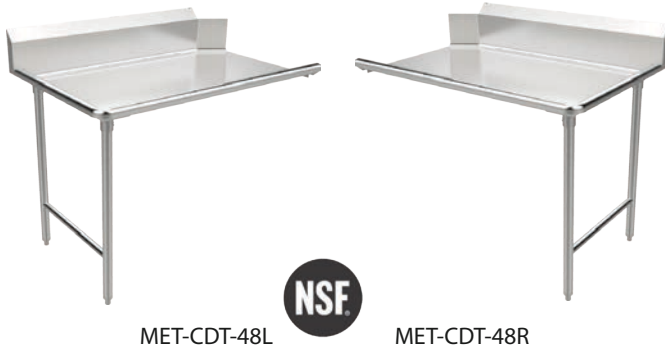

MET-CDT-48L

MET-CDT-48R

- 9" height backsplash
- 304 S/S 16 Ga. table top
- Stainless steel legs with side cross bracing
- NSF listed

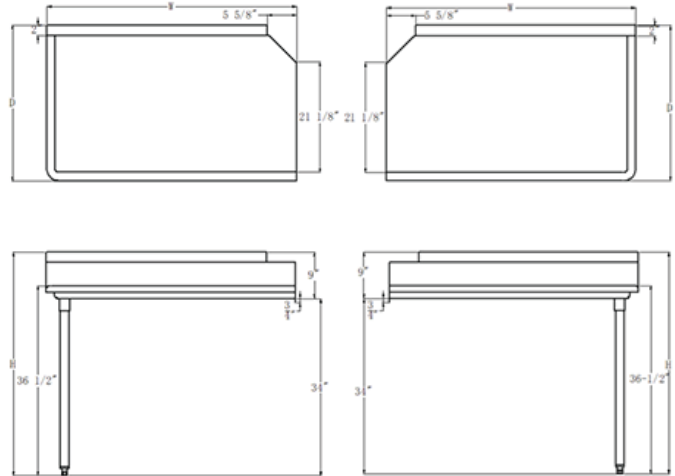

L  
Left Side Model

R  
Right Side Model

MODEL NO.	DIMENSION	LBS	LIST PRICE
MET-CDT-24L	D30" W24" H43"	30	\$ 592
MET-CDT-24R	D30" W24" H43"	30	\$ 592
MET-CDT-30L	D30" W30" H43"	34	\$ 663
MET-CDT-30R	D30" W30" H43"	34	\$ 663
MET-CDT-36L	D30" W36" H43"	38	\$ 711
MET-CDT-36R	D30" W36" H43"	38	\$ 711
MET-CDT-48L	D30" W48" H43"	50	\$ 829
MET-CDT-48R	D30" W48" H43"	50	\$ 829
MET-CDT-60L	D30" W60" H43"	60	\$ 948
MET-CDT-60R	D30" W60" H43"	60	\$ 948
MET-CDT-72L	D30" W72" H43"	68	\$ 1,186
MET-CDT-72R	D30" W72" H43"	68	\$ 1,186

## Wall Shelf



MET-WS-1472



MET-WS-1430

- 430 S/S 18 Ga.
- S/S mounting brackets included
- Shipped knocked-down in a box
- Units with pot rack comes with double pot hooks
- NSF listed

MODEL NO.	DIMENSION	BRACKETS	LBS	LIST PRICE
MET-WS-1424	D14" W24" H9-1/2"	2	9	\$ 117
MET-WS-1430	D14" W30" H9-1/2"	2	11	\$ 131
MET-WS-1436	D14" W36" H9-1/2"	2	12	\$ 141
MET-WS-1448	D14" W48" H9-1/2"	3	16	\$ 164
MET-WS-1460	D14" W60" H9-1/2"	3	20	\$ 202
MET-WS-1472	D14" W72" H9-1/2"	3	23	\$ 236
MET-WS-1824	D18" W24" H9-1/2"	2	12	\$ 188
MET-WS-1830	D18" W30" H9-1/2"	2	14	\$ 212
MET-WS-1836	D18" W36" H9-1/2"	2	16	\$ 236
MET-WS-1848	D18" W48" H9-1/2"	2	20	\$ 259
MET-WS-1860	D18" W60" H9-1/2"	3	24	\$ 307
MET-WS-1872	D18" W72" H9-1/2"	3	28	\$ 354

## Wall Shelf with Pot Rack



MET-WSP-1560

- Same as Above
- Stainless Steel Double Hooks



MODEL NO.	DIMENSION	BRACKETS	HOOKS	LIST PRICE
MET-WSP-1524	D15" W24"	2	4	\$ 188
MET-WSP-1530	D15" W30"	2	5	\$ 212
MET-WSP-1536	D15" W36"	2	6	\$ 236
MET-WSP-1548	D15" W48"	3	8	\$ 283
MET-WSP-1560	D15" W60"	3	10	\$ 307
MET-WSP-1572	D15" W72"	3	12	\$ 331
MET-WSP-1584	D15" W84"	4	14	\$ 426
MET-WSP-1596	D15" W96"	4	16	\$ 473

## Slanted Rack Wall Shelf



MET-SW-4222



- 430 S/S 18 Ga. shelf
- S/S mounting brackets included
- Drain on the left
- Shipped knocked-down in a box
- NSF listed

MODEL NO.	DIMENSION	# OF BRACKETS	LBS	LIST PRICE
MET-SW-2122	D22" W21" H15-1/2"	2	15	\$ 218
MET-SW-4222	D22" W42" H15-1/2"	2	25	\$ 328
MET-SW-6322	D22" W63" H15-1/2"	2	35	\$ 438

Effective May 2026

1750 Stone Ridge Drive, Stone Mountain, Georgia | CSR@ATSMFG.com | 770-270-1688

## Tubular Drainage Shelf



MET-TDDS-4815\*

- Wall-mounted drainage shelf
- Stainless steel construction
- Mounting bolts included
- NSF listed

MODEL NO.	DIMENSION	WEIGHT	O.D. TUBING SIZE	LIST PRICE
MET-TDDS-2415*	D15" W24"	12	1-5/8"	\$ 141
MET-TDDS-3615*	D15" W36"	16		\$ 188
MET-TDDS-4815*	D15" W48"	22		\$ 212
MET-TDDS-6015*	D15" W60"	30		\$ 236
MET-TDDS-7215*	D15" W72"	40		\$ 259

## Microwave Oven Shelf

- 430 S/S 18 Ga. shelf
- S/S mounting brackets included
- Shipped knocked-down in a box
- NSF listed



MET-MS-2418

MODEL NO.	DIMENSION	BRACKETS	LBS	LIST PRICE
MET-MS-2418	D18" W24" H14"	2	14	\$ 250

## Ceiling Mount Pot Rack

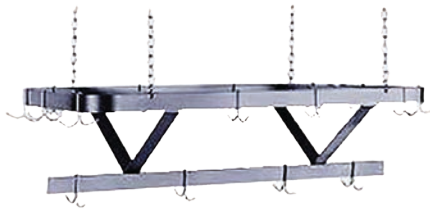

- Ceiling hung pot racks
- Triple bar design
- Stainless steel construction
- 24" plated hanging chains included
- NSF Listed

MET-PRC-72

MODEL NO.	DIMENSION	HOOKS	LIST PRICE
MET-PRC-36	D22" W36"	12	\$ 639
MET-PRC-48	D22" W48"	14	\$ 711
MET-PRC-60	D22" W60"	18	\$ 806
MET-PRC-72	D22" W72"	22	\$ 877

## Wall-mounted Pot Rack

- Wall-mounted pot racks
- Double bar design
- Stainless steel construction
- NSF Listed

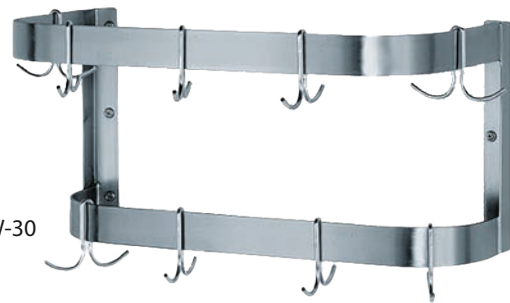

MET-PRW-30

MODEL NO.	DIMENSION	HOOKS	LIST PRICE
MET-PRW-24	D12" W24"	8	\$ 402
MET-PRW-30	D12" W30"	10	\$ 449
MET-PRW-36	D12" W36"	12	\$ 473
MET-PRW-48	D12" W48"	14	\$ 473
MET-PRW-60	D12" W60"	18	\$ 568
MET-PRW-72	D12" W72"	22	\$ 616



# COMMERCIAL KITCHEN FAUCETS

## Pre-rinse Faucet Sets, Heavy-duty

- FLO-988 wall / splash mounted with 12" or 14" add on spout, quarter-turn ceramic cartridges with color coded handles
- All stainless steel sprayer head for FLO-988 series
- FLO-981 deck mounted with 12" or 14" add on spout, compression valves with color coded handles, ceramic cartridge replacement available
- 1.2 GPM sprayer head
- Heavy duty brass construction and polished chrome finish
- 44" standard hose
- Lead free

**Lead Free Faucets**  
All faucets conform to AB 1953 and 2014 Federal Lead Free Standards.









FLO-98812  
FLO-98814



FLO-98112  
FLO-98114

MODEL NO.	DESCRIPTION	INLET TYPE	LIST PRICE
FLO-98812	8" Wall-mounted Pre-rinse Faucet with 12" Spout (Ceramic)	1/2 NPT Female	\$ 792
FLO-98814	8" Wall-mounted Pre-rinse Faucet with 14" Spout (Ceramic)	1/2 NPT Female	\$ 797
FLO-98112*	4" Deck Mount Pre-rinse Faucet with 12" Spout	1/2 NPT Female	\$ 488
FLO-98114*	4" Deck Mount Pre-rinse Faucet with 14" Spout	1/2 NPT Female	\$ 496

## Pre-rinse Accessories and Parts

MODEL NO.	DESCRIPTION	LIST PRICE	
 FLO-9300	FLO-9300	Ultra-Spray Valve, with 0.65 GPM nozzle, interchangeable with FLO-9200 & FLO Pre-rinse units	\$ 173
 FLO-9200	FLO-9200	1.2 GPM Pre-rinse Spray Valve, heavy-duty body with metal construction to prevent leaks (standard)	\$ 173
 FLO-9201	FLO-9201	Hose grip, lead free	\$ 33
 FLO-9203	FLO-9203	Blue bumper rings for 9200 spray valve	\$ 10
 FLO-9210	FLO-9210	Hose hook for FLO Pre-rinse units	\$ 23
 FLO-904	FLO-904	Pre-rinse hose spring	\$ 73
 FLO-911	FLO-911	Pre-rinse hose assembly with hose grip, 44", lead free	\$ 150

- Contact Us for Pre-rinse Replacement Parts
- See Replacement Base on Page 49

Effective May 2026

1750 Stone Ridge Drive, Stone Mountain, Georgia | CSR@ATSMFG.com | 770-270-1688





# COMMERCIAL KITCHEN FAUCETS

## Wall-mounted Faucet, Heavy-duty

- Engineered for high performance & durability
- Quarter-turn ceramic cartridges with Hot & Cold color coded handles
- Heavy duty brass construction and polished chrome body
- Heavy duty double O-ring swivel spout
- Lead free



### Lead Free Faucets

All faucets conform to AB 1953 and 2014 Federal Lead Free Standards.



FLO-800 series

MODEL NO.	DESCRIPTION	LIST PRICE	PCS/CASE	LBS
FLO-808	Wall-mounted Faucet 8" with 8" Spout (Compression Valve)	\$ 291	12	54
FLO-810	Wall-mounted Faucet 8" with 10" Spout	\$ 291	12	56
FLO-812	Wall-mounted Faucet 8" with 12" Spout	\$ 297	12	57
FLO-814	Wall-mounted Faucet 8" with 14" Spout	\$ 302	12	60
FLO-816	Wall-mounted Faucet 8" with 16" Spout	\$ 306	12	57

## Wall-mounted Faucet, Commercial-duty

- Engineered for performance & durability
- Reinforced double O-ring valves with Hot & Cold color coded handles
- Heavy duty brass construction and polished chrome body
- Heavy duty double O-ring swivel spout
- Lead free



### Lead Free Faucets

All faucets conform to AB 1953 and 2014 Federal Lead Free Standards.



FLO-700 series

MODEL NO.	DESCRIPTION	LIST PRICE	PCS/CASE	LBS
FLO-706	Wall-mounted Faucet 8" with 6" Spout	\$ 156	12	37
FLO-708	Wall-mounted Faucet 8" with 8" Spout	\$ 156	12	37
FLO-710	Wall-mounted Faucet 8" with 10" Spout	\$ 164	12	35
FLO-712	Wall-mounted Faucet 8" with 12" Spout	\$ 172	12	36
FLO-714	Wall-mounted Faucet 8" with 14" Spout	\$ 172	12	41
FLO-716	Wall-mounted Faucet 8" with 16" Spout	\$ 176	12	43

• Replacement parts, see page 48 & 49

Effective May 2026

1750 Stone Ridge Drive, Stone Mountain, Georgia | CSR@ATSMFG.com | 770-270-1688





# COMMERCIAL KITCHEN FAUCETS

## 4" Wall-mounted Faucet for Bar Sink

- Engineered for high performance & durability
- Reinforced double O-ring valves with Hot & Cold color coded handles
- Compression nuts & washers attached
- Heavy duty double O-ring swivel spout
- 1/2" NPS male inlets
- Stem check unit replacement available
- Lead free

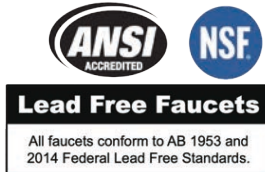

FLO-4106

MODEL NO.	DESCRIPTION	LIST PRICE	PCS/CASE	LBS
FLO-4106	4" Wall-mounted Faucet with 6" Spout	\$ 106	24	53
FLO-4108	4" Wall-mounted Faucet with 8" Spout	\$ 151	12	28
FLO-4110	4" Wall-mounted Faucet with 10" Spout	\$ 151	12	28
FLO-4112	4" Wall-mounted Faucet with 12" Spout	\$ 163	12	31

## 4" Deck Faucet for Bar Sink

- Engineered for high performance & durability
- Reinforced double O-ring valves with Hot & Cold color coded handles
- Compression nuts & washers attached
- Heavy duty double O-ring swivel spout
- 1/2" NPS male inlets
- Stem check unit replacement available
- Lead free

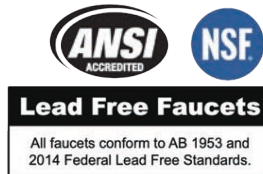

FLO-4206

MODEL NO.	DESCRIPTION	LIST PRICE	PCS/CASE	LBS
FLO-4206	4" Deck Mount Faucet with 6" Spout	\$ 122	24	46
FLO-4208	4" Deck Mount Faucet with 8" Spout	\$ 127	12	28
FLO-4210	4" Deck Mount Faucet with 10" Spout	\$ 132	12	28
FLO-4212	4" Deck Mount Faucet with 12" Spout	\$ 132	12	31

- Replacement parts, see page 48 & 49

Effective May 2026

1750 Stone Ridge Drive, Stone Mountain, Georgia | CSR@ATSMFG.com | 770-270-1688





# COMMERCIAL KITCHEN FAUCETS

## 4" Goose-Neck Wall-mounted Faucet for Hand / Bar Sink

- Engineered for high performance & durability
- Reinforced double O-ring valves with Hot & Cold color coded handles
- Compression nuts & washers attached
- Heavy duty double O-ring swivel spout
- 1/2" NPS male inlets
- Stem check unit replacement available
- Lead free

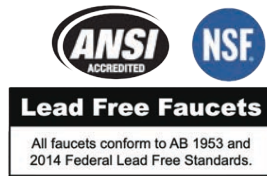

FLO-410

MODEL NO.	DESCRIPTION	LIST PRICE	PCS/CASE	LBS
FLO-410	4" Wall-mounted Faucet with 3-1/2" Gooseneck Spout	\$ 127	24	58
FLO-4105	4" Wall-mounted Faucet with 5" Gooseneck Spout	\$ 142	24	62

## 4" Goose Neck Deck Mount Faucet for Bar Sink

- Engineered for high performance & durability
- Reinforced double O-ring valves with Hot & Cold color coded handles
- Compression nuts & washers attached
- Heavy duty double O-ring swivel spout
- 1/2" NPS male inlets
- Stem check unit replacement available
- Lead free

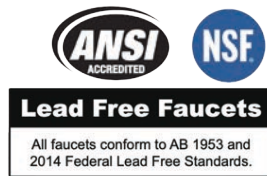

FLO-420

MODEL NO.	DESCRIPTION	LIST PRICE	PCS/CASE	LBS
FLO-420	4" Deck Mount Faucet with 3-1/2" Gooseneck Spout	\$ 122	24	58
FLO-4205	4" Deck Mount Faucet with 5" Gooseneck Spout	\$ 137	24	62

• Replacement parts, see page 48 & 49

Effective May 2026

1750 Stone Ridge Drive, Stone Mountain, Georgia | CSR@ATSMFG.com | 770-270-1688





# COMMERCIAL KITCHEN FAUCETS

## Automatic Wok Range Faucet

- 3/8" or 1/2" NPT male inlet
- 14" Spout
- Automatic turns on when spout is swung over wok
- Lead free

Automatic Wok Range Faucet with 14" Spout



### Lead Free Faucets

All faucets conform to AB 1953 and 2014 Federal Lead Free Standards.



FLO-510



FLO-517

MODEL NO.	DESCRIPTION	LIST PRICE	PCS/CASE	LBS
FLO-510	Automatic Wok Range Faucet 3/8" Inlet	\$ 137	24	44
FLO-517	Automatic Wok Range Faucet 1/2" Inlet	\$ 123	24	44

## Wok Range Faucet

- Single wall mount
- 14" Spout
- 2.0 GPM aerator 1/2" NPS male inlet
- Full replacement parts available
- Lead free



### Lead Free Faucets

All faucets conform to AB 1953 and 2014 Federal Lead Free Standards.



FLO-513

MODEL NO.	DESCRIPTION	LIST PRICE	PCS/CASE	LBS
FLO-513	Chinese Range Faucet 1/2" Inlet	\$ 147	24	54

Effective May 2026

1750 Stone Ridge Drive, Stone Mountain, Georgia | CSR@ATSMFG.com | 770-270-1688





# COMMERCIAL KITCHEN FAUCETS

## Mop Sink Faucet with Support Bracket

- 8" center heavy duty quality
- Quarter-turn ceramic cartridge with color coded handles, offering superior durability and leak resistance
- Built-in vacuum breaker
- 6-1/2" Spout with 3/4" hose thread
- Wall bracket with 12" rod
- 1/2" NPT female inlets
- Full replacement parts available
- Lead free



FLO-840

MODEL NO.	DESCRIPTION	LIST PRICE
FLO-840	Mop Sink Faucet with Support Bracket	\$ 381

- Replacement parts, see page 48 & 49

Effective May 2026

1750 Stone Ridge Drive, Stone Mountain, Georgia | CSR@ATSMFG.com | 770-270-1688



# LIT COMMERCIAL WARMERS & PROOFERS

## Strip Warmer



LIT-AEBH-48

- Infrared heating element
- With on/off toggle switch
- Indicator light, Aluminum shell
- Cord & plug included



MODEL NO.	DIMENSION	POWER	LIST PRICE
LIT-AEBH-24	D24" W6-3/4" H2-3/4"	120v/60/1-ph, 500 watts, 4.2 amps	\$ 222
LIT-AEBH-30	D30" W6-3/4" H2-3/4"	120v/60/1-ph, 650 watts, 5.4 amps	\$ 245
LIT-AEBH-36	D36-1/4" W6-3/4" H2-3/4"	120v/60/1ph, 850 watts, 7.1 amps	\$ 261
LIT-AEBH-42	D42-1/4" W6-3/4" H2-3/4"	120v/60/1ph, 1050 watts, 8.8 amps	\$ 264
LIT-AEBH-48	D48" W6-3/4" H2-3/4"	120v/60/1ph, 1200 watts, 10 amps	\$ 285
LIT-AEBH-54	D54" W6-3/4" H2-3/4"	120v/60/1ph, 1425 watts, 12 amps	\$ 300
LIT-AEBH-60	D60" W6-3/4" H2-3/4"	120v/60/1ph, 1550 watts, 13 amps	\$ 315
LIT-AEBH-72	D72" W6-3/4" H2-3/4"	120v/60/1ph, 1725 watts, 14.5 amps	\$ 393

## Cook & Hold Warmer, Counter-top



LIT-AECFW-12

- Wet operation, adjustable thermostat
- Cycling indicator pilot light
- Stainless steel construction
- 120v/60/1ph, 1500 watts, NEMA 5-15P



MODEL NO.	DESCRIPTION	AMPS	LIST PRICE
LIT-AECFW-12	Accepts 12" x 20" full size pan	13.6 amps	\$ 223
LIT-AECFW-43	Holds (4) each 1/3 size pans	12.5 amps	\$ 348

Effective May 2026

1750 Stone Ridge Drive, Stone Mountain, Georgia | CSR@ATSMFG.com | 770-270-1688

**ATSMFG**

# LIT COMMERCIAL WARMERS & PROOFERS

## Chip Warmer



LIT-AECW26

- Top load style, first in/first out design
- Clamp-on removable heating module
- Adjustable rear-mounted thermostat (90°F-190°F)
- 4" - 5" Adjustable legs
- 120v/60/1ph, 1500 watts, 12.5 amps, NEMA 5-15P



MODEL NO.	DIMENSION	CAPACITY	LIST PRICE
LIT-AECW26	D30-1/2" W26-1/2" H30-1/2"	26 gallon	\$ 2,125
LIT-AECW46	D30-1/2" W26-1/2" H38"	46 gallon	\$ 2,875

• See MET Chip Warmer Cart Available on Page 9

## Wok Range



LIT-AEWR-13

- Stainless steel construction
- 12" heavy duty legs
- CSA & CSA Sanitation



MODEL NO.	BURNER OPENING	BTU	LIST PRICE
LIT-AEWR-13	13"	125,000	\$ 1,398
LIT-AEWR-16	16"	160,000	\$ 1,648

Effective May 2026

1750 Stone Ridge Drive, Stone Mountain, Georgia | CSR@ATSMFG.com | 770-270-1688

**ATSMFG**

# LIT COMMERCIAL WARMERS & PROOFERS

## Warming Drawers



LIT-AEDW-1



- Stainless steel construction
- (1) 12" x 20" x 6" stainless steel pan
- Free standing
- Individual thermostat controls
- Moist/crisp door vents
- 5" adjustable legs, 120v/60/1-ph, 3.75 amps



LIT-AEDW-2



- Stainless steel construction
- (2) 12" x 20" x 6" stainless steel pan
- Free standing
- Individual thermostat controls
- Moist/crisp door vents
- 5" adjustable legs, 120v/60/1-ph, 7.5 amps



LIT-AEDW-3



- Stainless steel construction
- (3) 12" x 20" x 6" stainless steel pan
- Free standing
- Individual thermostat controls
- Moist/crisp door vents
- 5" adjustable legs, 120v/60/1-ph, 11.25 amps

MODEL NO.	DIMENSION	LIST PRICE
LIT-AEDW-1	D21" W27-3/4" H14-7/8"	\$ 1,280
LIT-AEDW-2	D21" W27-3/4" H24-1/4"	\$ 1,965
LIT-AEDW-3	D21" W27-3/4" H33-5/8"	\$ 2,665

Effective May 2026

1750 Stone Ridge Drive, Stone Mountain, Georgia | CSR@ATSMFG.com | 770-270-1688

**ATSMFG**

# LIT COMMERCIAL WARMERS & PROOFERS

## Heated Holding & Proofing Cabinets



LIT-AEHP05WR-ICD

- Fully insulated
- Aluminum construction
- Removable bottom mount control module
- Thermostat up to 185°F
- 120v/60/1-ph, NEMA 5-15P
- Polycarbonate clear door and solid aluminum door options



LIT-AEHP16WR-ICD



LIT-AEHP16WR-ISDD

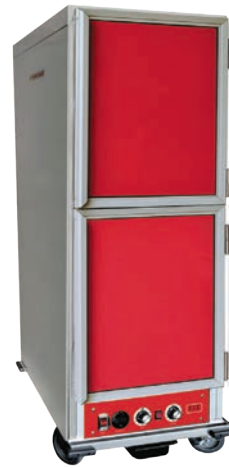

LIT-AEHP36-ISDD



LIT-AEHP36-ICD

MODEL NO.	DOOR TYPE	DIMENSION	LIST PRICE
LIT-AEHP05WR-ICD	Clear Polycarbonate	D(5) 12" W20" H2-1/2"	\$ 3,230
LIT-AEHP16WR-ICD	Clear Polycarbonate	D(16) 12" W20" H2-1/2"	\$ 3,545
LIT-AEHP16WR-ISDD	Solid Dutch	D(16) 12" W20" H2-1/2"	\$ 3,700
LIT-AEHP36-ISDD	Solid Dutch	(36) 18" x 26"	\$ 3,248
LIT-AEHP36-ICD	Clear Polycarbonate	(36) 18" x 26"	\$ 3,248

Effective May 2026

1750 Stone Ridge Drive, Stone Mountain, Georgia | CSR@ATSMFG.com | 770-270-1688



# ATSMFG Policies & Terms

This section provides a high-level overview of ATSMFG's terms, ordering process, shipping practices, and warranty coverage. It is designed to help dealers and partners understand how we work together. For complete and most current policies, please visit [www.atsmfg.com](http://www.atsmfg.com) or contact our Customer Service team.

## Terms & Conditions

All sales are subject to ATSMFG's Terms & Conditions.

By submitting a purchase order to ATSMFG, the customer agrees to comply with and be bound by these terms.

ATSMFG's written Order Acknowledgment, generated from the customer's purchase order, constitutes the governing agreement for production, shipment, and invoicing. Customers are responsible for reviewing all ATS communications carefully.

## Ordering & Handling

Ordering Process: All purchase orders must be submitted in writing. Orders enter production once:

- Credit terms are approved
- Pricing and freight are confirmed
- All product specifications are complete

ATSMFG will issue a written Order Acknowledgment confirming product details, quantities, pricing, freight terms, and requested ship or pick-up dates. Customers must review the Order Acknowledgment promptly and report any discrepancies within 24 hours of receipt.

**Pricing, Quotes & Payment Terms:** All pricing is quoted in U.S. dollars and is subject to change without notice. Product and freight quotes are typically valid for 15 days, unless otherwise stated. Lead times are estimates based on current production schedules and material availability and may change if conditions evolve.

New accounts may require deposits or prepayment. Credit terms are available to approved accounts. Accounts with past-due balances may be placed on credit hold, which may delay production or shipment.

**Order Changes & Cancellations:** All order changes and cancellations must be submitted in writing and are subject to ATS approval. Approved changes may result in additional costs, including materials, labor, or restocking fees. Orders already in production or completed may not be eligible for cancellation.

## Shipping & Freight

Shipping Methods & Routing: ATSMFG ships within the continental United States. Shipping is arranged according to instructions provided on the purchase order:

- Customer's third-party carrier
- ATSMFG-arranged freight (freight quote provided for approval)
- Freight charges & delivery requirements must be confirmed prior to shipment

**Customer Pick-Up:** Customer-arranged pick-up is available by appointment. Pick-up vehicles must be appropriate for the size and weight of the order.

ATSMFG reserves the right to refuse release of merchandise if the vehicle is deemed unsafe or unsuitable. Pick-up delays may result in storage or handling fees.

**Delivery Inspection & Freight Claims:** Customers are responsible for inspecting shipments at the time of delivery. Visible damage must be noted on the delivery receipt before signing. Concealed damage must be reported promptly and original packaging retained. ATSMFG assumes responsibility for freight damage only on shipments arranged through ATSMFG freight accounts, subject to proper documentation and claim timelines. Freight claims must be submitted in writing using the ATSMFG Freight Claim Evaluation Form.

**Unforeseen Delays:** ATSMFG is not responsible for delays or inability to perform caused by events beyond our reasonable control, such as material shortages, transportation disruptions, labor interruptions, public health events, or government actions. If such circumstances arise, we will communicate promptly and work in good faith with our customers to adjust

## Warranty & Returns

ATSMFG provides limited warranties across our product categories to cover qualifying manufacturer defects in materials and workmanship. Warranty coverage varies by product type and is subject to the terms outlined in the applicable warranty documentation.

- Furniture: We warrant qualifying furniture products against manufacturer defects in materials and workmanship for one (1) year from the original date of purchase.
- Equipment: MET and FLO products are covered under a one (1) year limited warranty against defects in materials or workmanship under normal use. LIT equipment is covered under a one (1) year limited warranty and serviced by Consumer Priority Service (CPS).

**What Is Not Covered:** Normal wear and tear; Improper use, installation, or maintenance; Products sold as custom, closeout, as-is, or used; Natural material variations, including wood grain, color variation, or minor warping

**Warranty Claims Process & Timing:** Warranty claims must be submitted in writing using the ATSMFG Warranty Evaluation Form. Claims must be reported within the timeframe specified in the applicable warranty. Upon review, ATSMFG will advise on repair, replacement, or other resolution if the claim is approved.

Returns: Non-warranty returns require prior written authorization. Approved returns may be subject to restocking and handling fees and must be freight prepaid. Custom products are not eligible for return.

## Contacting ATSMFG

Everyone at ATSMFG is available on email via [FirstName@ATSMFG.com](mailto:FirstName@ATSMFG.com) or phone during business hours.

- Freight Quotes: [Freight@ATSMFG.com](mailto:Freight@ATSMFG.com)
- Questions: [CSR@ATSMFG.com](mailto:CSR@ATSMFG.com)
- Orders: [PO@ATSMFG.com](mailto:PO@ATSMFG.com)
- Phone: 770-270-1688
- Text: 404-625-7432



Effective May 2026

1750 Stone Ridge Drive, Stone Mountain, Georgia | [CSR@ATSMFG.com](mailto:CSR@ATSMFG.com) | 770-270-1688

**ATSMFG**

 MET

 FLO

 LIT

MISC  
&  
PARTS  
PARTS

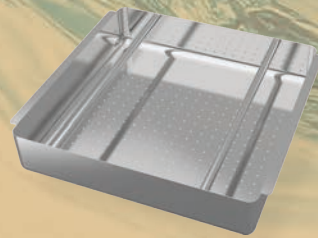

**Stainless Steel Trash Receptacle**



MET-TR1-SS

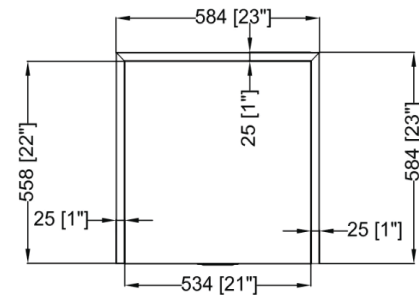
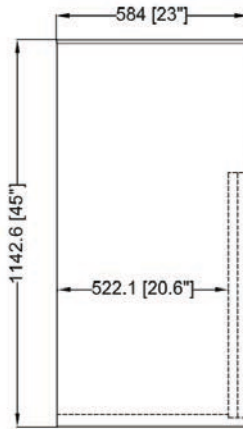
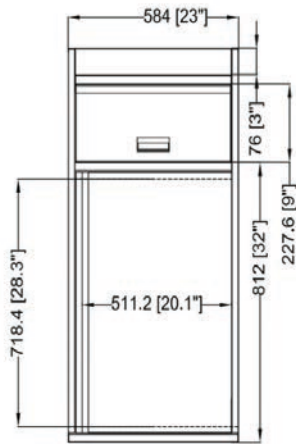
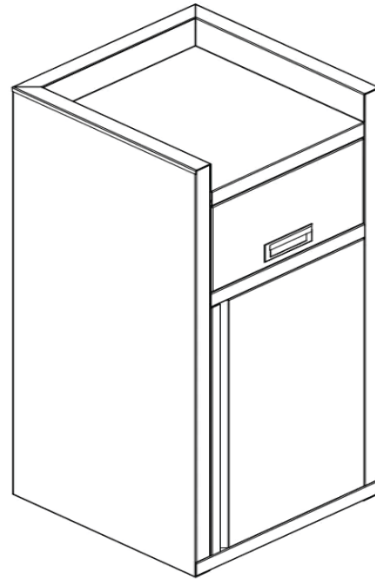

MODEL NO.	DIMENSION	LIST PRICE
MET-TR1-SS	D22" W23" H45"	\$ 1088

## Epoxy-coated Wire Shelving

- 850 lbs capacity for shelves shorter than 60"
- 600 lbs capacity for 60" & above shelves
- 74" height posts for shelving unit
- 2 shelves per box, 4 post per carton
- **Ten (10) years corrosion and rust warranty on MET Green Epoxy Shelves**
- **Must purchase full box quantity**

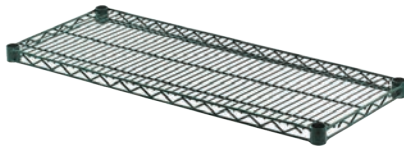

MET-GS1460

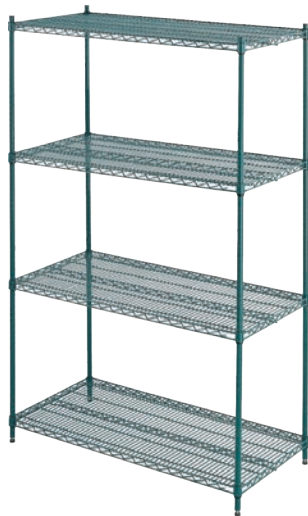

MET-GS2448-4

- See Casters Available on page 41
- See Shelf Accessories Available on Page 42

### GREEN EPOXY WIRE, SHELVING UNITS (4 shelves)

MODEL NO.	DIMENSION	LBS	LIST PRICE
MET-GS1424-4	D14" W24" H74"	52	\$ 191
MET-GS1436-4	D14" W36" H74"	68	\$ 231
MET-GS1448-4	D14" W48" H74"	88	\$ 276
MET-GS1454-4	D14" W54" H74"	100	\$ 289
MET-GS1460-4	D14" W60" H74"	112	\$ 321
MET-GS1824-4	D18" W24" H74"	60	\$ 213
MET-GS1836-4	D18" W36" H74"	80	\$ 258
MET-GS1848-4	D18" W48" H74"	104	\$ 308
MET-GS1854-4	D18" W54" H74"	112	\$ 329
MET-GS1860-4	D18" W60" H74"	124	\$ 375
MET-GS1872-4	D18" W72" H74"	148	\$ 412
MET-GS2436-4	D24" W36" H74"	104	\$ 303
MET-GS2448-4	D24" W48" H74"	128	\$ 362
MET-GS2454-4	D24" W54" H74"	148	\$ 397
MET-GS2460-4	D24" W60" H74"	168	\$ 452
MET-GS2472-4	D24" W72" H74"	195	\$ 520

### GREEN EPOXY WIRE, INDIVIDUAL SHELVES

MODEL NO.	DIMENSION	LBS	LIST PRICE
MET-GS1424	D14" W24"	12	\$ 29
MET-GS1436	D14" W36"	16	\$ 39
MET-GS1448	D14" W48"	21	\$ 50
MET-GS1454	D14" W54"	24	\$ 56
MET-GS1460	D14" W60"	27	\$ 61
MET-GS1824	D18" W24"	14	\$ 34
MET-GS1836	D18" W36"	19	\$ 46
MET-GS1848	D18" W48"	25	\$ 58
MET-GS1854	D18" W54"	27	\$ 66
MET-GS1860	D18" W60"	30	\$ 75
MET-GS1872	D18" W72"	36	\$ 84
MET-GS2436	D24" W36"	25	\$ 57
MET-GS2448	D24" W48"	31	\$ 72
MET-GS2454	D24" W54"	36	\$ 83
MET-GS2460	D24" W60"	41	\$ 94
MET-GS2472	D24" W72"	48	\$ 111

Effective May 2026

1750 Stone Ridge Drive, Stone Mountain, Georgia | CSR@ATSMFG.com | 770-270-1688

## Keg Rack



MET-KRA-60



- 3 tier keg racks
- Rear straps can be purchased separately
- 1-5/16" diameter. Aluminum post

MODEL NO.	DIMENSION	# OF 1/2 KEGS	LIST PRICE
MET-KRA42	D20" W42" H76"	4	\$ 948
MET-KRA60	D20" W60" H76"	6	\$ 1091
MET-KRA72	D20" W72" H76"	8 (tight)	\$ 1186
MET-KRA80	D20" W80" H76"	8 (loose)	\$ 1328
MET-KRA93	D20" W93" H76"	10	\$ 1423

### ALUMINUM REAR STRAPS FOR KEG RACKS

MODEL NO.	DESCRIPTION	LIST PRICE
MET-KRA142	For 42" Keg Rack	\$ 188
MET-KRA160	For 60" Keg Rack	\$ 236
MET-KRA172	For 72" Keg Rack	\$ 259
MET-KRA180	For 80" Keg Rack	\$ 283
MET-KRA193	For 93" Keg Rack	\$ 307

## Utility Carts



MET-UBC-WS1836



- Wire utility cart
- 250 lbs capacity
- 3 shelves
- 4 swivel rubber casters with 2 brakes

MODEL NO.	DIMENSION	LIST PRICE
MET-UBC-WS1836	D18" W36" H38"	\$ 402
MET-UBC-WS2142	D21" W42" H33"	\$ 473



MET-UBC-2135SH



- 3 shelves utility cart
- 16 gauge angle legs
- 18 gauge 304 S/S construction
- All welded
- 350 lbs capacity

MODEL NO.	DIMENSION	LIST PRICE
MET-UBC-1624SH	D15-1/2" W27" H33-1/2"	\$ 521
MET-UBC-1827SH	D18" W27" H34"	\$ 592
MET-UBC-2135SH	D21" W35" H34"	\$ 616

Effective May 2026

# MET SUPPLIES & MISCELLANEOUS

## Bun Pan Rack



MET-BPR20

- Open sides bun pan racks
- 3" spacing
- Welded angle slides
- 5" swivel casters
- Aluminum construction
- Ship knock-down
- NSF listed

MODEL NO.	DIMENSION	PAN CAPACITY & SIZE	LIST PRICE
MET-BPR10	H38-1/2" W20-3/8" D26"	(10) 18" x 26"	\$ 307
MET-BPR20	H65-1/2" W20-3/8" D26"	(20) 18" x 26"	\$ 378

# LIT SUPPLIES & MISCELLANEOUS

## Swinging Traffic Door, Pro



LIT-AEKD-36

- Tempered aluminum with satin anodized finish
- Hinge included
- 9" x 14" window for both sizes

MODEL NO.	FITS DOOR OPENING	LIST PRICE
LIT-AEKD-30	30" x 84"	\$ 873
LIT-AEKD-36	36" x 84"	\$ 898

Effective May 2026

1750 Stone Ridge Drive, Stone Mountain, Georgia | CSR@ATSMFG.com | 770-270-1688



## Counter-mounted Can Opener



LIT-AECO-1

MODEL NO.	DESCRIPTION	LIST PRICE
LIT-AECO-1	#1 Can Opener with Stainless Steel Base	\$ 123

- Replacement parts, see page 50

## Film Wrapping Dispenser

- 22-1/2"W x 26"D x 5"H, one roll capacity
- Stainless steel and aluminum construction
- 120v/60/1-ph, 6.5 amps, 725 watts
- Film roll not included



LIT-AEFW-18



MODEL NO.	DESCRIPTION	LIST PRICE
LIT-AEFW-18	Heat Seal Film Wrapping Dispenser	\$ 1123

## Stainless Steel Work Table Undershef

- 430 S/S 18 Ga. undershef
- Fits MET WTHB, WTH, WT series work table
- NSF listed

MET-WT-US2472  
MET-WT-US3072  
MET-WT-US3096



MET-WT-US3030

MODEL NO.	DIMENSION	FIT TABLE SIZE	LBS	LIST PRICE
MET-WT-US2430	D19-4/5" W25-1/3" H2"	24" x 30"	10	\$ 188
MET-WT-US2436	D19-4/5" W31-1/3" H2"	24" x 36"	12	\$ 212
MET-WT-US2448	D19-4/5" W43-1/3" H2"	24" x 48"	16	\$ 247
MET-WT-US2460	D19-4/5" W55-1/3" H2"	24" x 60"	20	\$ 283
MET-WT-US2472	D19-4/5" W67-1/3" H2"	24" x 72"	25	\$ 357
MET-WT-US3030	D25-4/5" W25-1/3" H2"	30" x 30"	13	\$ 212
MET-WT-US3036	D25-4/5" W31-1/3" H2"	30" x 36"	15	\$ 236
MET-WT-US3048	D25-4/5" W43-1/3" H2"	30" x 48"	20	\$ 271
MET-WT-US3060	D25-4/5" W55-1/3" H2"	30" x 60"	25	\$ 307
MET-WT-US3072	D25-4/5" W67-1/3" H2"	30" x 72"	30	\$ 354
MET-WT-US3096	D25-4/5" W91-1/3" H2"	30" x 96"	46	\$ 497

## Stainless Steel Double Overshef

- 430 S/S 18 Ga. table top & undershef
- S/S post, adjustable lower shelf
- L-shaped table mounting bracket
- Shipped knocked-down in a box
- NSF listed



MET-DOS-1448





MODEL NO.	DIMENSION	LBS	LIST PRICE
MET-DOS-1436	D14" W36" H32"	30	\$ 426
MET-DOS-1446V	D14" W45-1/5" H32"	34	\$ 711
MET-DOS-1448	D14" W48" H32"	36	\$ 473
MET-DOS-1460	D14" W60" H32"	41	\$ 544
MET-DOS-1472	D14" W72" H32"	47	\$ 616
MET-DOS-1474	D14" W74" H32"	50	\$ 639
MET-DOS-1476V	D14" W76" H32"	55	\$ 948
MET-DOS-1836	D18" W36" H32"	35	\$ 521
MET-DOS-1848	D18" W48" H32"	42	\$ 568
MET-DOS-1860	D18" W60" H32"	49	\$ 616
MET-DOS-1872	D18" W72" H32"	56	\$ 687
MET-DOS-1896	D18" W96" H32"	65	\$ 853

Effective May 2026







## Caster Sets for Work Tables & Equipment Stands

- All Casters sold by set (4 each per set)
- 220 lbs capacity per caster, 500 lbs capacity per caster for heavy duty models
- Grease resistance, swivel with breaks

### CASTER SETS FOR MET EQUIPMENT

	MODEL NO.	DESCRIPTION	USAGE	DIA.	LBS	LIST PRICE
	MET-CS4153	1-1/2" Stem	Work table & Equipment Stand	3"	7.3	\$ 148
	MET-CS6115	Stem Shelving Caster	Wire Shelving	5"	9.5	\$ 148
	MET-CS6155	1-1/2" Stem	Work table & Equipment Stand	5"	8.5	\$ 123









### CASTER SETS FOR GENERAL USE

	MODEL NO.	DESCRIPTION	USAGE	DIA.	LBS	LIST PRICE
	MET-CS4003	1/2"-13 x 1 Threaded Stem	Reach-in & Merchandiser	4"	5.8	\$ 148
	MET-CS6005	4" x 5" Plate	Back Bar unit	3"	8.0	\$ 223
	MET-CS4453T	1/2"-13 x 1 Threaded Stem	Reach-in & Merchandiser	5"	8.5	\$ 123
	MET-CS6235	2-3/8" x 3-5/8" Plate	Cooking Equipment	5"	8.5	\$ 123
	MET-CS6335	3-1/2" x 3-1/2" Plate	Cooking Equipment	5"	9.8	\$ 123
	MET-CS6345HD	3" x 4" Heavy-duty Plate	Double Stack Convection Oven	5"	9.8	\$ 198
	MET-CS6557HD	5-3/8" x 5-3/8" x 7-1/2" Heavy-duty Triangle Plate	Double Stack Convection Oven	5"	13.7	\$ 248

Effective May 2026

1750 Stone Ridge Drive, Stone Mountain, Georgia | CSR@ATSMFG.com | 770-270-1688

## Epoxy-coated Shelving Parts

	MODEL NO.	DESCRIPTION	LBS	LIST PRICE
	MET-GSWB-14	14" Wall Bracket (pair)	3.2	\$ 38
	MET-GSWB-18	18" Wall Bracket (pair)	3.7	\$ 49
	MET-GSWB-24	24" Wall Bracket (pair)	4.5	\$ 58
	MET-GSWBD-14	14" Double Bracket (EA)	3.2	\$ 43
	MET-GSWBD-18	18" Double Bracket (EA)	3.7	\$ 47
	MET-GSWBD-24	24" Double Bracket (EA)	4.5	\$ 50
	MET-GS-CLIP	Wire shelving clips (set)	0.1	\$ 13
	MET-GS-FOOT	Wire shelving foot, (set of 4)	0.3	\$ 3
	MET-GSC074	74" H shelving post	3.2	\$ 20

## S/S Baskets / Splash Guards

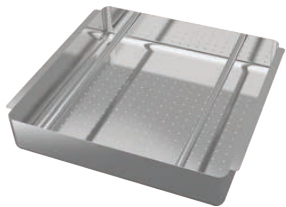

MET-SDT-2020

- 304 S/S 18 Ga.
- Perforated basket
- NSF listed

Pre-rinse BASKET			
MODEL NO.	FOR SINK BOWL SIZE	LBS	LIST PRICE
MET-SDT-2020	20" x 20"	12.0	\$ 262

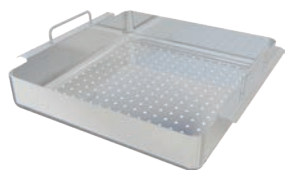

MET-PSB-1515

- 304 S/S 16 Ga.
- Perforated basket
- 3" deep basket
- NSF listed

PREP SINK BASKET			
MODEL NO.	FOR SINK BOWL SIZE	LBS	LIST PRICE
MET-PSB-1515	15" x 15"	7.0	\$ 212
MET-PSB-1620	16" x 20"	9.5	\$ 236
MET-PSB-1818	18" x 18"	9.5	\$ 236
MET-PSB-2020	20" x 20"	11.0	\$ 283
MET-PSB-2424	24" x 24"	15.0	\$ 331



MET-SSG18

- 304 S/S 18 Ga.
- Welded bracket
- NSF listed

SINK SPLASH GUARDS			
MODEL NO.	FOR SINK BOWL SIZE	LBS	LIST PRICE
MET-SSG15	15"	3.0	\$ 141
MET-SSG18	18"	4.0	\$ 164
MET-SSG20	20"	4.0	\$ 188
MET-SSG24	24"	5.0	\$ 212



MET-FSG2012

- 430 S/S 18 Ga.
- Welded bracket
- NSF listed

FRYER SPLASH GUARD			
MODEL NO.	L X D	LBS	LIST PRICE
MET-FSG2012	20" x 12"	4.0	\$ 93

## Work Table Drawer

- Heavy duty drawer for work table
- Ball bearing slides
- 200 lbs load capacity
- Stainless steel construction
- NSF listed



MET-DA-1818

MODEL NO.	DIMENSION	LBS	LIST PRICE
MET-DA-1818	W18" D18"	25.0	\$ 307

## Fryer Accessories



MET-JSFF21

- 430 S/S 22 Ga.



FRYER JOINER STRIP			
MODEL NO.	DIMENSION	LBS	LIST PRICE
MET-JSFF21	W20-1/2" D2" H2"	1.0	\$ 69
MET-JSFF23	W22-1/2" D2" H2"	1.0	\$ 69
MET-JSFF27	W27" D2" H2"	1.2	\$ 69



MET-BH50

FRYER BASKET HANGER			
MODEL NO.	DIMENSION	LBS	LIST PRICE
MET-BH50	W15-1/3" D4-1/2" H2"	2.0	\$ 188
MET-BH75	W21" D4-1/2" H2"	2.6	\$ 236

## Hood Filters

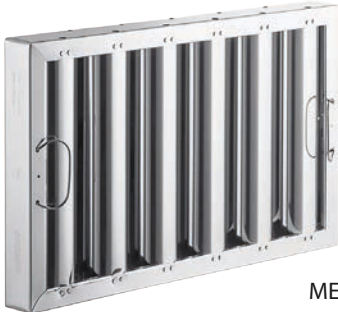

MET-F1620



- Dimension are in nominal
- Dish washer safe
- Built-in handles
- Stainless steel
- 6 each per box (minimum order per box)
- Fully interchangeable with existing filters
- NSF & UL certified



MET-F2020

MODEL NO.	DIMENSION	LIST PRICE
MET-F1216	H12" W16" D2"	\$ 60
MET-F1616	H16" W16" D2"	\$ 60
MET-F1620	H16" W20" D2"	\$ 68
MET-F1625	H16" W25" D2"	\$ 84
MET-F2016	H20" W16" D2"	\$ 68
MET-F2020	H20" W20" D2"	\$ 84
MET-F2025	H20" W25" D2"	\$ 90



MET-FT1721

(Fits all standard size exhaust hood filters)

HOOD FILTER SOAKING TANK		
MODEL NO.	DIMENSION	LIST PRICE
MET-FT1721	H34" W17" D21"	\$ 1186



# PARTS & ACCESSORIES

## Operation Valve - Knee Action

- Engineered for high performance & durability
- Rough chrome plated body
- Self closing valves
- Red & blue indexed brass pedals with polished chrome finish
- 1/2" NPT female inlets & 1/2" NPT female outlet
- Replacement for self-closing valve available



FLO-203

### Lead Free Faucets

All faucets conform to AB 1953 and 2014 Federal Lead Free Standards.



MODEL NO.	DESCRIPTION	LIST PRICE	PCS/CASE	LBS
FLO-203	Knee Action Valve with Red & Blue index	\$ 245	12	47.2

## Operation Valve - Foot Action

- Engineered for high performance & durability
- Rough chrome plated body
- Self closing valves
- Red & blue indexed brass pedals with polished chrome finish
- 1/2" NPT female inlets & 1/2" NPT female outlet
- Replacement for self-closing valve available

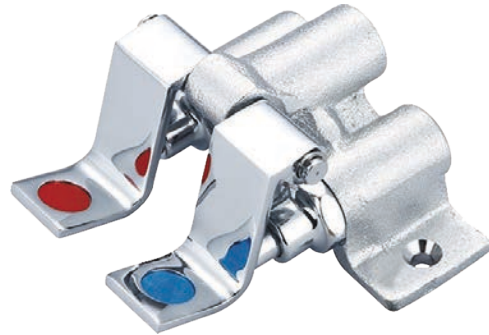

FLO-202

### Lead Free Faucets

All faucets conform to AB 1953 and 2014 Federal Lead Free Standards.



MODEL NO.	DESCRIPTION	LIST PRICE	PCS/CASE	LBS
FLO-202	Foot Pedal Operation Valve with Red & Blue index	\$ 238	12	35.8

Effective May 2026

1750 Stone Ridge Drive, Stone Mountain, Georgia | CSR@ATSMFG.com | 770-270-1688





# PARTS & ACCESSORIES

## Waste Water Valve - Lever Handle Style



FLO-302



### Lead Free Faucets

All faucets conform to AB 1953 and 2014 Federal Lead Free Standards.

MODEL NO.	DESCRIPTION	LIST PRICE	PCS/CASE	LBS
FLO-302	Lever Handle Waste Valve 3-1/2" Sink Opening, 2" Drain Outlet	\$ 127	12	46.3

## Waste Water Valve - Twist Handle Style



FLO-303



### Lead Free Faucets

All faucets conform to AB 1953 and 2014 Federal Lead Free Standards.

MODEL NO.	DESCRIPTION	LIST PRICE	PCS/CASE	LBS
FLO-303	Twist Handle Waste Valve 3-1/2" Sink Opening, 2" Drain Outlet	\$ 127	12	44.1

• Replacement Parts, See Page 49

Effective May 2026





1750 Stone Ridge Drive, Stone Mountain, Georgia | CSR@ATSMFG.com | 770-270-1688









# PARTS & ACCESSORIES

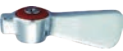

## Wall-mounted Faucet Parts

	MODEL NO.	DESCRIPTION	LIST PRICE	PCS/CASE	LBS
	FLO-100	Stem check unit for 7- Series, Cold	\$ 25	12	53.8
	FLO-101	Stem check unit for 7- Series, Hot	\$ 25	12	55.1
	FLO-102	Quarter-turn ceramic cartridge for 8- & 9- Series, Cold	\$ 69	20	56.5
	FLO-103	Quarter-turn ceramic cartridge for 8- & 9- Series, Hot	\$ 69	20	59.1
	FLO-4789W	Mounting kit for FLO Wall-mounted Faucets	\$ 55	20	14.0

## 4" Mount Faucet Parts

	MODEL NO.	DESCRIPTION	LIST PRICE	PCS/CASE	LBS
	FLO-122	B-Handle, Cold, with Blue index	\$ 13	20	3.0
	FLO-123	B-Handle, Hot, with Red index	\$ 13	20	3.0
	FLO-161	Stem Assembly for 4-series, Cold	\$ 33	20	6.0
	FLO-162	Stem Assembly for 4-series, Hot	\$ 33	20	6.0
	FLO-4789D	Mounting kit for FLO Deck Mount faucets	\$ 55	20	14.0

## Wok Faucet Parts

	MODEL NO.	DESCRIPTION	LIST PRICE	PCS/CASE	LBS
	FLO-122	B-Handle, Cold, with Blue index	\$ 13	20	1.0
	FLO-104	Stem Check Unit for Chinese Wok Faucet, stainless steel indicator	\$ 40	20	2.0

Effective May 2026

1750 Stone Ridge Drive, Stone Mountain, Georgia | CSR@ATSMFG.com | 770-270-1688







# PARTS & ACCESSORIES

## Pre-rinse Wall-mounted Base



- Quarter-turn ceramic cartridge valves with color indicated handle
- Lead free
- NSF listed

	MODEL NO.	DESCRIPTION	LIST PRICE	PCS/CASE	LBS
	FLO-988B	Pre-rinse Faucet Base Only	\$ 277	12	3.9

## Operation Valve Parts

	MODEL NO.	DESCRIPTION	LIST PRICE	PCS/CASE	LBS
	FLO-907	Spray Valve Assembly, Lead free, for Knee and Foot Operated Valves	\$ 55	20	6.0

## Handle Waste Valve With Strainer Parts

	MODEL NO.	DESCRIPTION	LIST PRICE	PCS/CASE	LBS
	FLO-300PT	3-1/2" Rubber Seal Washer for FLO Waste Valves	\$ 5	20	1.0
	FLO-305PT	Flat strainer for twist handle waste	\$ 33	20	2.0

Effective May 2026

1750 Stone Ridge Drive, Stone Mountain, Georgia | CSR@ATSMFG.com | 770-270-1688



## Strip Heater Stands



LIT-AEBH-CLS (Bar Heater not included)



LIT-AEBH-TLS (Bar Heater not included)

MODEL NO.	DESCRIPTION	LIST PRICE
LIT-AEBH-CLS	C-Leg stand (Bar Heater Not Include) (2 per set)	\$ 88
LIT-AEBH-TLS	T-Leg stand ( Bar Heater Not Include ) (2 per set)	\$ 178

## Can Opener Parts



LIT-AECO-1G



LIT-AECO-1K

MODEL NO.	DESCRIPTION	LIST PRICE
LIT-AECO-1G	Gear for use #1 Can Opener	\$ 18
LIT-AECO-1K	Knife for use #1 Can Opener	\$ 10



## WARRANTY INFO



## WARRANTY INFO

**LIMITED WARRANTY:** ATSMFG warrants all MET Stainless Steel & FLO Faucet products, when properly installed and subject to normal use, are free from defects in material or workmanship for a period up to one (1) year.

With regard to these equipment, a defect shall refer to a variance from the design specifications that prohibit the Equipment from operating for its intended use. The Warranty provided by ATSMFG does not impose any duty or liability upon ATSMFG for degradation that occurs in the normal course over time, or due to improper installation of the Equipment by Purchaser or their representative.

**CORROSION and RUST WARRANTY on MET Green Epoxy Green Shelves:** MET Green Epoxy Wire Shelvings, Shelving Units, and Wall Brackets also carries a warranty against corrosion and rust formation following Ten (10) Years from Product Ship Date.

Determination of repair or replacement will be at the sole discretion of ATSMFG.

### EXCLUSION FROM WARRANTY COVERAGE:

- A. Any damage occurring, at any time, during shipping of Equipment unless otherwise provided for in the Agreement. When returning Equipment to ATSMFG for repair or replacement, Purchaser assumes all risk of loss or damage, and agrees to use any shipping containers that might be provided by ATSMFG and to ship the Equipment in the manner prescribed by ATSMFG;
- B. Any damage caused by improper installation and/or use, overloading, accident, improper storage, or neglect, alterations, modifications, or additions;
- C. Any statement made about the product by salesman, dealers, distributors or agents, unless such statements are in a written document signed by an officer of ATSMFG. Such statements are not included in a signed writing do not constitute warranties, shall not be relied upon by Purchaser and are not part of the contract of sale.

**PURCHASER'S INSPECTION UPON RECEIPT OF EQUIPMENT:** All Equipment shall be carefully inspected by Purchaser upon receipt, be installed by persons who are trained and certified professionals with respect to such installation, and be installed, used, repaired and maintained by Purchaser in accordance with all applicable local laws, codes and regulations.

**ASSIGNMENT OF RIGHTS:** The Warranty contained herein extends only to the original Purchaser of the Equipment and no attempt to extend the Warranty to any subsequent user or transferee of the Equipment shall be valid or enforceable without the express written consent of ATSMFG. Any attempt by Purchaser to assign this Warranty shall render the Warranty.

Effective May 2026

1750 Stone Ridge Drive, Stone Mountain, Georgia | [Sales@ATSMFG.com](mailto:Sales@ATSMFG.com) | 770-270-1688



**LIMITED WARRANTY:** ATSMFG guarantees that its cooking equipment is free from defects in materials and workmanship under normal use for one (1) year from the original purchase date. During this period, Consumer Priority Service (CPS) will provide repair or replacement service for qualifying issues at no additional cost to the customer.

**What is Covered?:**

- A. Manufacturer defects in materials and workmanship
- B. Mechanical or electrical failure due to normal usage
- C. Replacement parts and labor for covered repairs
- D. On-site service or depot repair as determined by CPS

**What is NOT Covered?:**

- A. Damage caused by misuse, neglect, or improper installation
- B. Cosmetic damage (scratches, dents, or discoloration)
- C. Normal wear and tear
- D. Unauthorized repairs or modifications
- E. Damage caused by natural disasters or power surges

**How to Register Your Warranty:**

By Phone: Call 1-800-905-0443

Online: Visit [www.cpscentral.com](http://www.cpscentral.com) and click 'Register Your Plan'

**How to File a Warranty Claim:**

By Phone: Call 1-800-905-0443

Online: [www.cpscentral.com/how-to-file-a-claim/](http://www.cpscentral.com/how-to-file-a-claim/)

Have the following information ready: Warranty ID Number, Valid Proof of Purchase, Product Make, Model, and Serial Number

**PURCHASER'S INSPECTION UPON RECEIPT OF EQUIPMENT:** All Equipment shall be carefully inspected by Purchaser upon receipt, be installed by persons who are trained and certified professionals with respect to such installation, and be installed, used, repaired and maintained by Purchaser in accordance with all applicable local laws, codes and regulations.

**Additional Terms & Conditions:** This warranty is non-transferable and applies only to the original purchaser. ATSMFG and CPS are not responsible for incidental or consequential damages, and the warranty service is available only in the United States.

# ATSMFG **Front-of-House to Back-of-House. Exceptional Value, Reliable quality.**

For more than 30 years, **ATSMFG** has served the restaurant equipment industry with reliable quality, responsive service, and competitive pricing. What began as American Tables & Seating has grown into a complete restaurant project solutions partner. Sold via restaurant equipment dealers, foodservice providers, designers, and architects nationwide.

Through our family of brands, we design, manufacture, and source commercial furniture, equipment, tabletop, and supplies. Our solutions are designed to scale from single unit to multi-location roll-outs.



## **American Tables & Seating**

Complete seating and furniture solutions, from design to delivery. EZ, QuickShip, Built-to-Order, and Custom programs cover the full range of needs with commercial-grade seating, tables, and accessories engineered for comfort, and long-term performance in high-traffic environments.



## **Stone Mountain Tabletop**

A broad selection of dinnerware, drinkware, flatware, and serving pieces designed to elevate presentation and withstand the pace of daily service, all ideal for operators who need style, consistency, and replenishment.



## **MET Stainless**

Commercial stainless-steel equipment and powder-coated shelving built for demanding kitchens. Competitively priced and ready to ship. MET helps improve organization, workflow, and long-term reliability with practical, job-tested essentials.



## **FLO Commercial Faucets**

Heavy-duty commercial kitchen faucet and Pre-rinse solutions built for everyday durability. FLO Faucets support efficient dish and prep operations with dependable performance.



## **LIT Equipment**

Back-of-house equipment including warmers, proofers, and cabinets. LIT is designed to support efficient, high-volume kitchen operations where reliability and consistency matter.



## **Mama Lucy Restaurant Supplies**

Trusted supplies for decades, selected and approved by Mama Lucy. Everyday front-of-house and back-of-house essentials that keep operations running smoothly, shift after shift.



## **Z-Source Global Procurement & Logistics**

Our newest brand under the **ATSMFG** umbrella. Z-Source is built on more than 30 years as the behind-the-scenes backbone of **ATSMFG**.

Today, the expertise and convenience is available to all dealers! Z-Source provides white-glove, cost-effective, mixed-container procurement and logistics. Available from the smallest to the largest need for single and multi-location hospitality needs across the U.S.